

OWNER'S HANDBOOK FOR BUKH MARINE DIESEL ENGINE TYPE S270J



powering **marine** safety

BUKH A/S
Aabenraavej 13 - 17
DK - 6340 Krusaa
Tel: +45 74 62 20 88
bukh@bukh.dk
www.bukh.dk



INSTALLATION & OPERATION MANUAL

S270 Series Engines

HYUNDAI SEASALL

TABLE OF CONTENTS

ABOUT THIS MANUAL	3
SAFETY PRECAUTIONS	4
APPROXIMATE STANDARD CONVERSIONS	5
CHAPTER 1 ENGINE OVERVIEW	6
1. ENGINE COMPONENTS	6
2. ENGINE HANGER	7
3. ENGINE IDENTIFICATION	8
4. SCHEMATIC DIAGRAM OF COMMON RAIL DIESEL ENGINE	9
5. TECHNICAL DATA	10
6. PERFORMANCE CURVES	11
7. BELT INSTALLATION & ENGINE DIMESIONS.....	13
CHAPTER 2 ENGINE MOUNT SYSTEM	16
1. PREPARING THE ENGINE INSTALLATION	16
2. BELLHOUSING FIXING.....	18
3. ASSEMBLING ENGINE MOUNTS	18
CHAPTER 3 COOLING & EXHAUST SYSTEM	19
1. SCHEMATIC DIAGRAM OF ENGINE COOLING CIRCUIT	19
2. SEAWATER FLOW.....	20
2.1 WATER PICKUP	20
2.2 SEAWATER STRAINER	20
2.3 SEAWATER PUMP	21
3. ENGINE COOLANT FLOW.....	23
3.1 ENGINE COOLANT	23
3.2 REMOVING AIR BUBBLES.....	25
3.3 CABIN HEATER CONNECTION	25
4. EXHAUST SYSTEM	26
CHAPTER 4 FUEL SYSTEM	27
1. FUEL FLOW.....	28
2. LOW PRESSURE FUEL LINE	28
3. ACCELERATION SENSOR AND CONTROL LEVER	29
4. RECOMMENDED FUEL QUALITY	30
5. DRAINING WATER FROM FUEL FILTER	30
CHAPTER 5 AIR INTAKE SYSTEM	31
1. ENGINE AIR CONSUMPTION.....	31
2. ENGINE ROOM VENTILATION.....	31
3. AIR FILTER MAINTENANCE	32
CHAPTER 6 LUBRICATION SYSTEM	33
1. ENGINE OIL FLOW.....	33
2. ENGINE OIL LEVEL CHECKS	34
3. RECOMMENDED OIL QUALITY	34
4. ENGINE OIL EXTACTION PUMP	35
5. OIL FILTER REPLACEMENT	35

TABLE OF CONTENTS

CHAPTER 7	ELECTRICAL SYSTEM	36
	1. BATTERY CABLE CONNECTIONS	36
	2. BATTERY CHECKS	37
	3. FUSE AND RELAY	38
CHAPTER 8	INSTRUMENT SYSTEM	40
	1. INSTRUMENT CONNECTIONS	40
	2. CUT-OUT FOR GAUGE	43
	3. CUT-OUT FOR EOI SYSTEM	43
	4. SEASLINK PRODUCT COMPONENTS.....	45
	5. INSTALLATION OF SEASALINK DONGLE.....	46
CHAPTER 9	EOI SYSTEM	47
	1. OVERVIEW OF EOI SYSTEM	47
	1.1 INFORMATION LCD	47
	1.2 SWITCHES	48
	1.3 ALARM LAMPS	48
	2. EOI CONNECTIONS	49
	3. EOI PIN ASSIGNMENT	50
	4. NEUTRAL SWITCH AND DUAL EOI CONNECTION	52
	5. TRIM WIRING CONNECTION DIAGRAM (With NEW EOI)	53
	6. G-SCAN.....	71
	7. ALARM AND DTC(DIAGNOSIS TROUBLE CODE)	72
	7.1 ALARM LIST.....	72
	7.2 DTC(DIAGNOSIS TROUBLE CODE) LIST.....	75
CHAPTER 10	ANTI CORROSION SYSTEM	80
CHAPTER 11	ENGINE OPERATION	81
	1. ENGINE ON/OFF	81
	2. ENGINE BREAK-IN	82
	3. EMERGENCY STOP	83
CHAPTER 12	ENGINE STORAGE	84
	WINTER STORAGE.....	85
	LONG TERM STORAGE.....	86
CHAPTER 13	MAINTENANCE	87
	1. THE INITIAL RUNNING CHECK.....	87
	2. MAINTENANCE SCHEDULE	88
	3. STERNDRIVE & TRANSMISSION MAINTENANCE SCHEDULE	89
	4. MAINTENANCE LOG.....	90
CHAPTER 14	TROUBLESHOOTING GUIDE	91
CHAPTER 15	WARRANTY	93
	WARRANTY REGISTRATION CARD	98



ABOUT THIS MANUAL

This engine installation and operation manual is provided as guidance for the installation of a Hyundai SeasAll engine in a boat, and to describe engine operation. Its purpose is to provide technical information to aid in performing an effective engine installation so as to achieve both maximum performance and service life. For information on installation, operation and maintenance of the ZF Marine Transmissions and MerCruiser Bravo Sterndrive Models, please see the separate booklets included in the original packaging of your Hyundai SeasAll purchase.

Hyundai SeasAll is committed to making clear and accurate information available for those who maintain, own and repair the S270 Series engines. Hyundai SeasAll values your input regarding revisions and additional information for our manuals.

- The manufacturer is not liable for any damages or losses caused by faulty installation, wrong handling of the equipment and/or deficient maintenance.
- The operator is responsible for the correct and safe operation of the engine and safety of its occupants and general public.
- It is strongly recommended that each operator read and understand this manual before installing and operating the engine.
- This manual as well as safety labels posted on the engine use the following safety alerts to draw your attention to special safety instructions that should be followed.



WARNING

DEVIATION FROM INSTALLATION INSTRUCTIONS AND OPERATION GUIDELINES MAY LEAD TO PERSONAL INJURY OR DEATH TO OPERATORS AND NEARBY PERSONNEL.



CAUTION

DEVIATION FROM INSTALLATION INSTRUCTIONS AND OPERATION GUIDELINES MAY LEAD TO IMPROPER OPERATION, DAMAGE OR DESTRUCTION OF THE ENGINE.

SAFETY PRECAUTIONS

- Read and understand this operator's manual as well as other information supplied by Hyundai SeasAll for safe use of these products. Be sure to check your engine regularly.
- Do not use the engine for a purpose other than what is intended by Hyundai SeasAll. Do not modify the performance of the supplied engine without the express permission of Hyundai SeasAll. This can be dangerous, can shorten the life of your engine and can invalidate your warranty.
- Original and genuine parts supplied from Hyundai SeasAll must be used for inspections and maintenance. Hyundai SeasAll does not guarantee any damage caused by the use of imitation parts.
- Engine inspection and maintenance should be carried out by properly trained and factory approved service engineers.
- The engine should be inspected if the electronic engine control unit shuts down the engine.

HOT SURFACES AND FLUIDS

- There is always a risk of burns when working with a hot engine. Be aware of hot parts like the turbocharger system, the exhaust system, hot coolant hoses, etc. Wait until the engine is fully cool to do inspection and maintenance.

REFUELING

- Refuel only after the engine completely stops.
- Use only the recommended fuel. The wrong grade of fuel can cause operating problems, can cause the engine to stop and can cause engine damage.
- Pay special attention to safe practices when refueling.

PAINT DAMAGE

- Damage of the engine or parts paint during maintenance and inspection can cause corrosion. Any damage must be repainted after inspection and maintenance. Contact your Hyundai SeasAll dealer for touch-up paint.

WELDING ON ENGINE

- Welding directly on the engine block can cause damage to the engine control systems. The ECU and related electronic devices must be disconnected and removed if unavoidable welding is needed.



INSTALLATION & OPERATION MANUAL

S270 Series Engines

HYUNDAI SEASALL

APPROXIMATE STANDARD CONVERSIONS							
	SYMBOL	MULTIPLY BY	SYMBOL		SYMBOL	MULTIPLY BY	SYMBOL
LENGTH	mm	0.039	inch	LENGTH	inch	25.4	mm
	cm	0.4	inch		inch	2.54	cm
	m	3.28	ft		ft	0.3048	m
AREA	mm ²	0.0016	in ²	AREA	in ²	645.2	mm ²
	m ²	10.764	ft ²		ft ²	0.093	m ²
VOLUME	cm ³	0.061	in ³	VOLUME	in ³	16.388	cm ³
	mL	0.06	in ³		in ³	16	mL
	Ldm ³	61.023	in ³		in ³	0.016	Ldm ³
	Ldm ³	0.22	imp.gallon		imp.gallon	4.545	Ldm ³
	Ldm ³	0.264	U.S.gallon		U.S.gallon	3.785	Ldm ³
	m ³	0.76	yd ³		yd ³	1.3	m ³
	m ³	35.315	ft ³		ft ³	0.028	m ³
FORCE	kgf	2.204	lbf	FORCE	lbf	0.453	kgf
	N	0.224	lbf		lbf	4.448	N
TEMP.	°F=9/5x°C+32			TEMP.	°C=5/9x(°F-32)		
PRESSURE	Bar	14.5	psi	PRESSURE	psi	0.068	Bar
	MPa	145	psi		psi	0.0068	MPa
	Pa	0.102	mmWc		mmWc	9.807	Pa
	Pa	0.004	inWc		inWc	249.098	Pa
	KPa	4	inWc		inWc	0.249	KPa
	mWg	39.37	inWc		inWc	0.025	mWg
TORQUE	Nm	0.738	lbf ft	TORQUE	lbf ft	1.356	Nm
WEIGHT	kg	2.205	lb	WEIGHT	lb	0.454	kg
	kg	35.273	oz		oz	0.028	kg
WORK	kJ/kWh	0.43	BTU/lb	WORK	BTU/lb	2.326	kJ/kWh
	MJ/kg	430	BTU/lb		BTU/lb	0.0023	MJ/kg
	kJ/kg	0.24	Kcal/kg		Kcal/kg	4.184	kJ/kg
ENERGY	kJ/kg	0.697	BTU/hph	ENERGY	BTU/hph	1.435	kJ/kg
FUEL CONSUMP.	g/kWh	0.736	g/hph	FUEL CONSUMP.	g/hph	1.36	g/kWh
	g/kWh	0.0016	lb/hph		lb/hph	616.78	g/kWh
FLOW RATE (GAS)	m ³ /h	0.588	ft ³ /min	FLOW RATE (GAS)	ft ³ /min	1.699	m ³ /h
FLOW RATE (LIQUID)	m ³ /h	4.403	US gal/min	FLOW RATE (LIQUID)	US gal/min	0.2271	m ³ /h
SPEED	m/s	3.281	ft/s	SPEED	ft/s	0.3048	m/s
	km/h	0.539	knots		knots	1.852	km/h
	mph	0.869	knots		knots	1.1508	mph
	km/h	0.62	mph		mph	1.61	km/h

CHAPTER 1 ENGINE OVERVIEW

1. ENGINE COMPONENTS

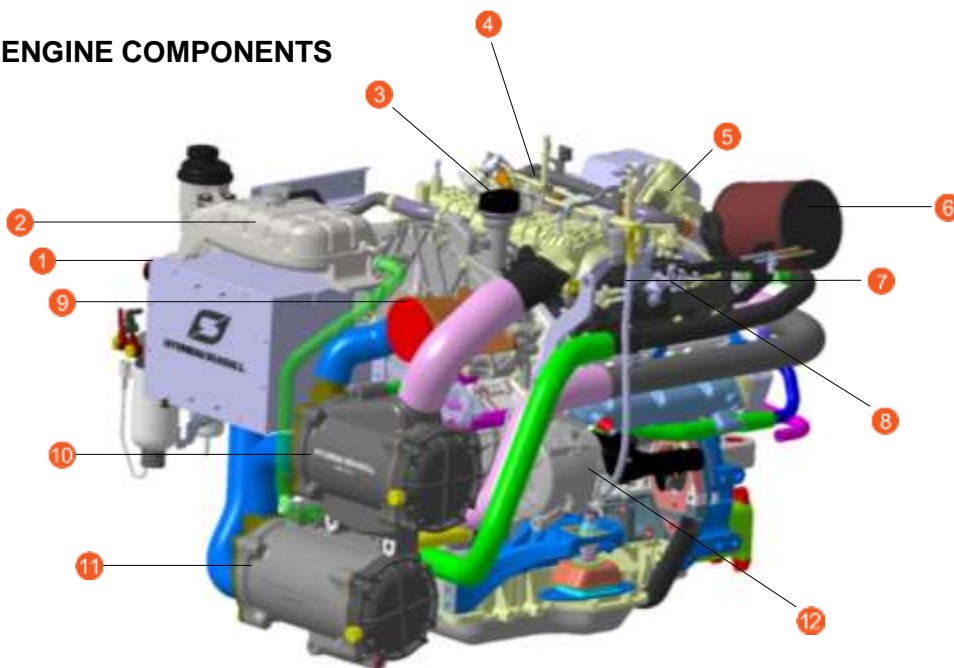

- | | |
|---------------------------|------------------------------|
| 1. ECU Box | 7. Engine Oil Gauge |
| 2. Coolant Expansion Tank | 8. Acceleration Lever Sensor |
| 3. Engine Oil Cap | 9. Seawater Pump |
| 4. Engine Oil Filter | 10. Intercooler |
| 5. E-VGT & Cooler | 11. Heat Exchanger |
| 6. Air Filter | 12. Alternator |

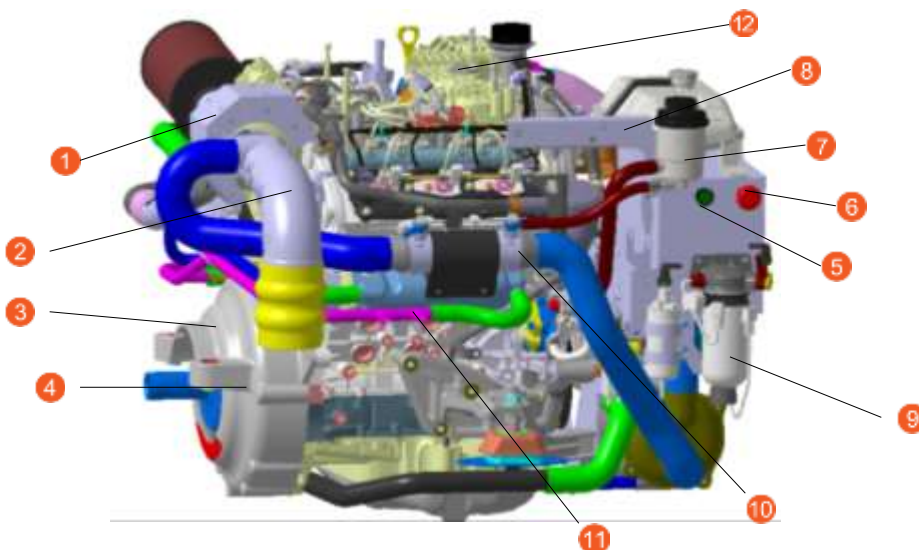

- | | |
|-------------------------------------|---|
| 1. Turbo Heat Protector | 7. Power Steering Oil Reservoir Tank (Sterndrive Model) |
| 2. Exhaust Elbow | 8. Shift Plate (Sterndrive Model) |
| 3. Bell Housing (Sterndrive Model) | 9. Main Fuel Filter with Water Detection Sensor |
| 4. Drive Coupler (Sterndrive Model) | 10. T/M Oil Cooler or P/STRG Oil Cooler |
| 5. Engine Oil Drain Pump Button | 11. Cabin Heater Connector |
| 6. Engine Emergency Stop Button | 12. Boost Pressure Sensor |

2. ENGINE HANGER

- 1) To lift the engine, first remove the engine cover. You will find three engine eyes (see figure).
- 2) To avoid damage to the engine or operator, take care that engine lift chains or belts do not hit or touch surrounding parts during engine lifting.

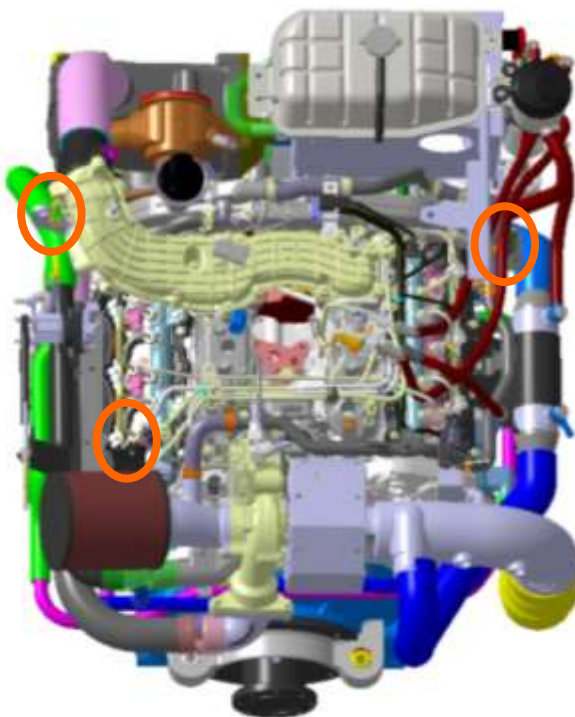

3. ENGINE IDENTIFICATION

Engine identification is affixed to the engine block and the ECU box (see figure).

- **SERIAL NUMBER ON THE ENGINE BLOCK**



- **NAME PLATE ON THE ECU BOX**

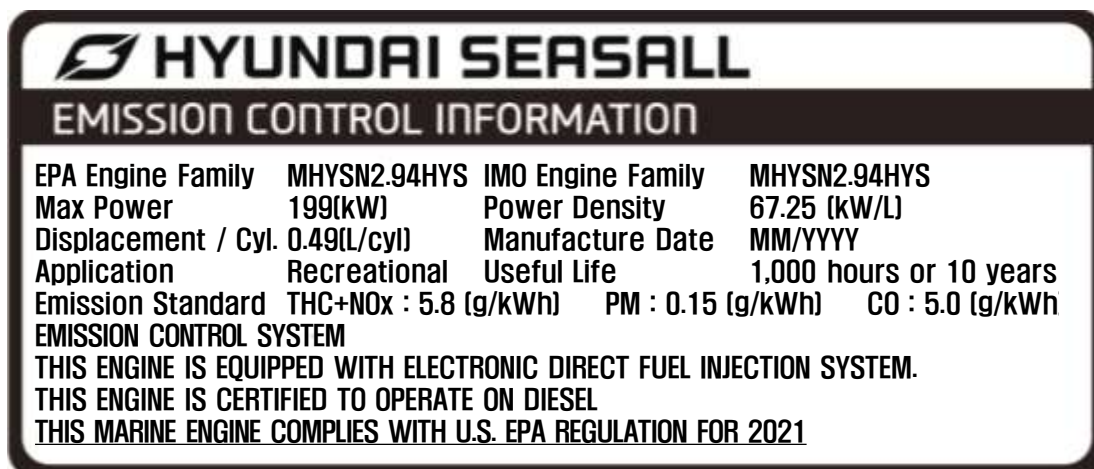

4. SCHEMATIC DIAGRAM OF COMMON RAIL DIESEL ENGINE

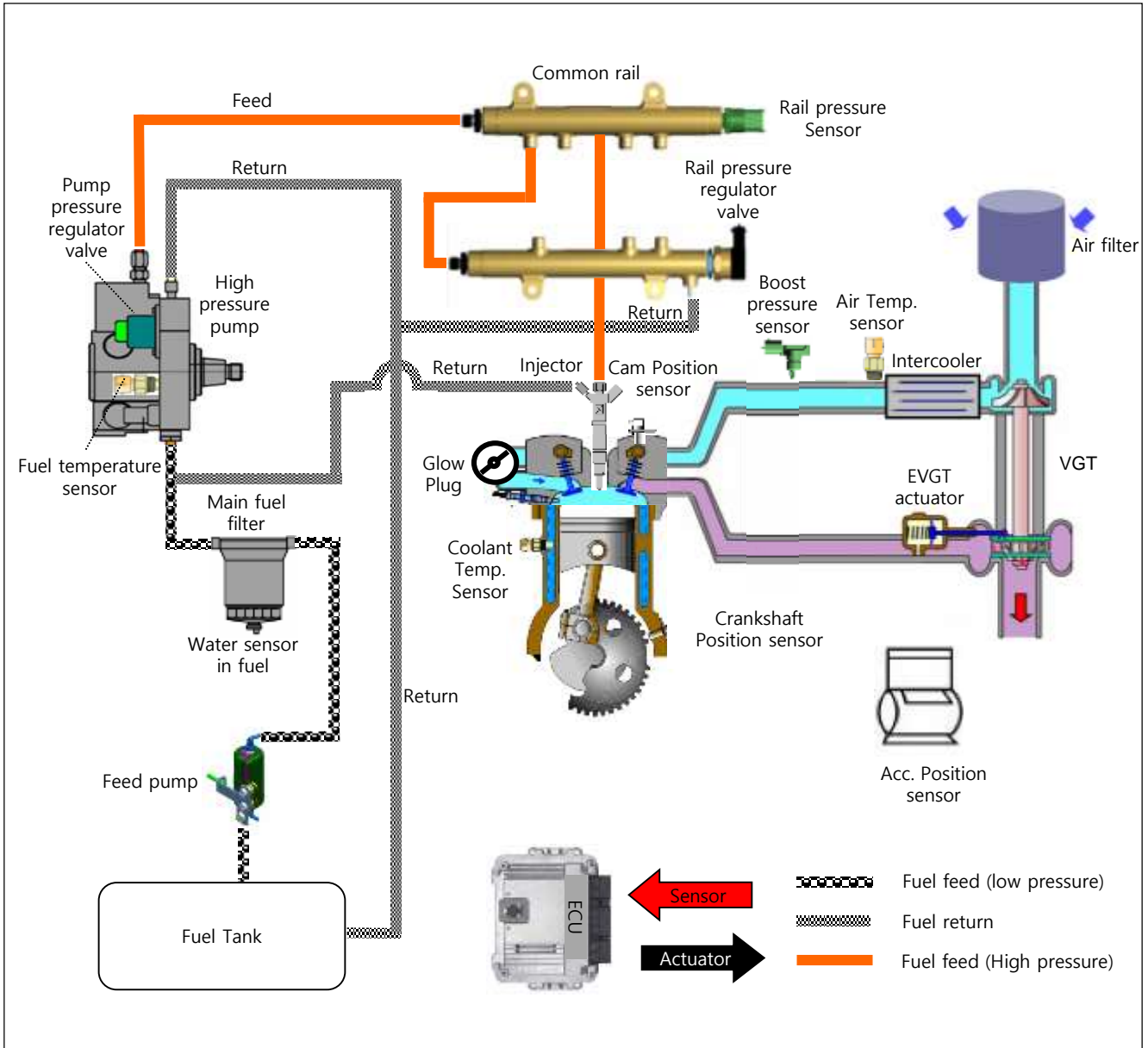



INSTALLATION & OPERATION MANUAL

S270 Series Engines

5. TECHNICAL DATA

	S270S	S270P	S270J
Engine type	4-stroke, 24-valve		
	After-cooled, direct-injection, water cooling		
Output PS(kW)	270PS (199)		
rpm at full load	3800		
Cylinders	V-6		
Ignition sequence	1-2-3-4-5-6		
Displacement [cm ³]	2959		
Bore [mm]	84		
Stroke [mm]	89		
Compression ratio	17.3±0.5 : 1		
Max. torque [kgm] @ speed [rpm]	57.6		51
	2500		3800
Injection system	Common rail direct injection (Piezo injector)		
Diesel fuel	at least CN 51 as per DIN EN 590		
Intake air pressure (abs. bar) @ speed [rpm]	2.78	2.78	2.78
	3800	3800	3800
Coolant quantity (liter)	13.15		
Coolant cap opening pressure (bar)	1.1		
Engine oil (liter)	7.7		
Engine oil pressure (bar)	2~3 at 1750rpm, 100 °C(oil temp.)		
Exhaust gas pressure (kPa)	Max. 50		
Alternator [A]	150		
Engine diagnosis	Yes		
Dry Weight / Gross Weight (kg)	334 / 377±3		
Battery capacity (AH)	12V, 200AH recommended		
Thermostat opening temp. (°C)	71 (starting to open), 83 (fully open)		
Idle rpm warmed up (rev/min)	680		
Permissible eng. oil temp (°C)	137		
Permissible eng. coolant temp (°C)	105		
Fuel Consumption (Rated) (l/hr) @	53.8 @ 3800 rpm		
Propulsion system	Sterndrive	Shaftdrive	Waterjet



6. PERFORMANCE CURVE

▪ S270S & S270P MODEL

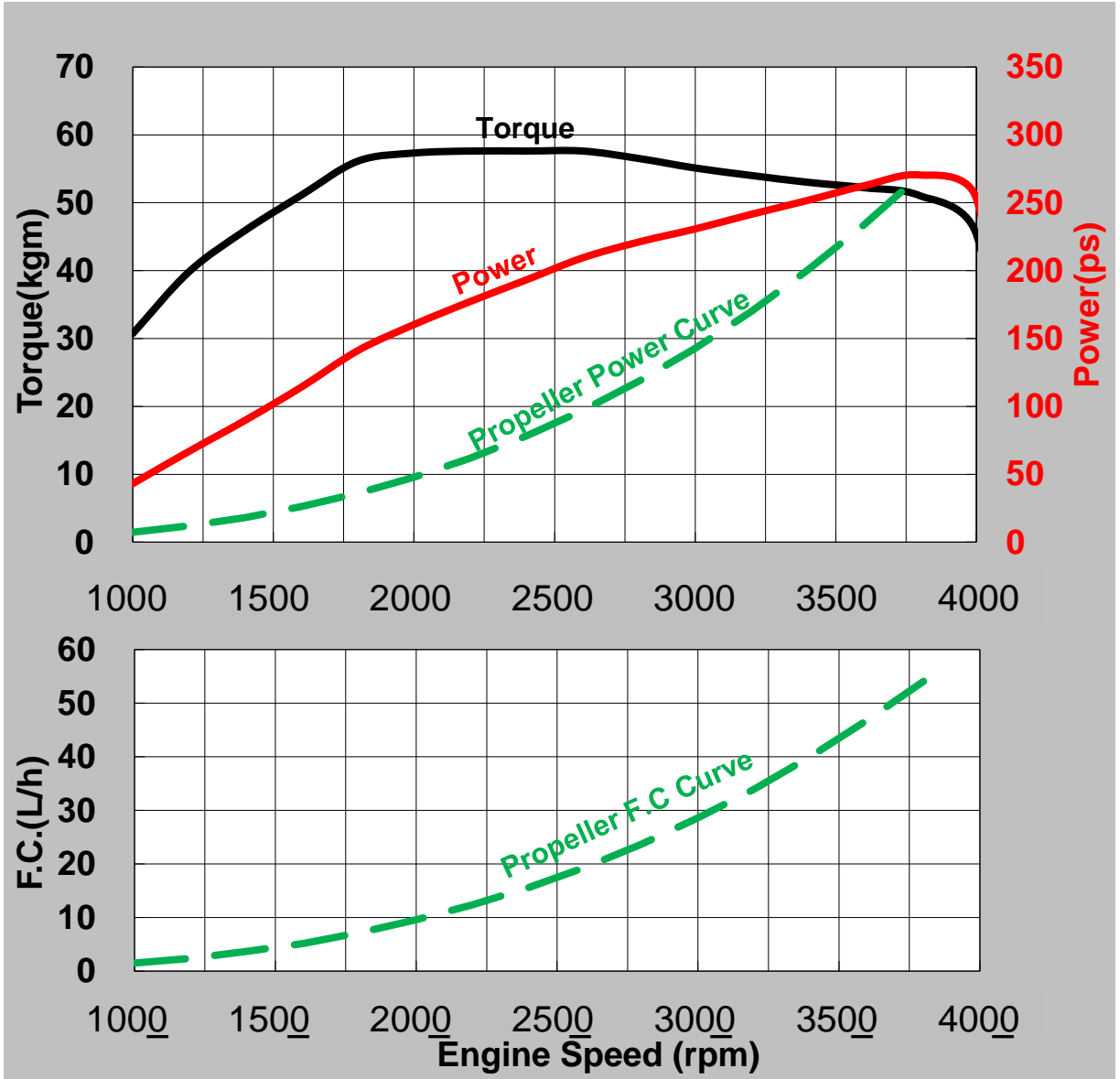

*F.C : Fuel Consumption



INSTALLATION & OPERATION MANUAL

S270 Series Engines

HYUNDAI SEASALL

▪ S270J MODEL

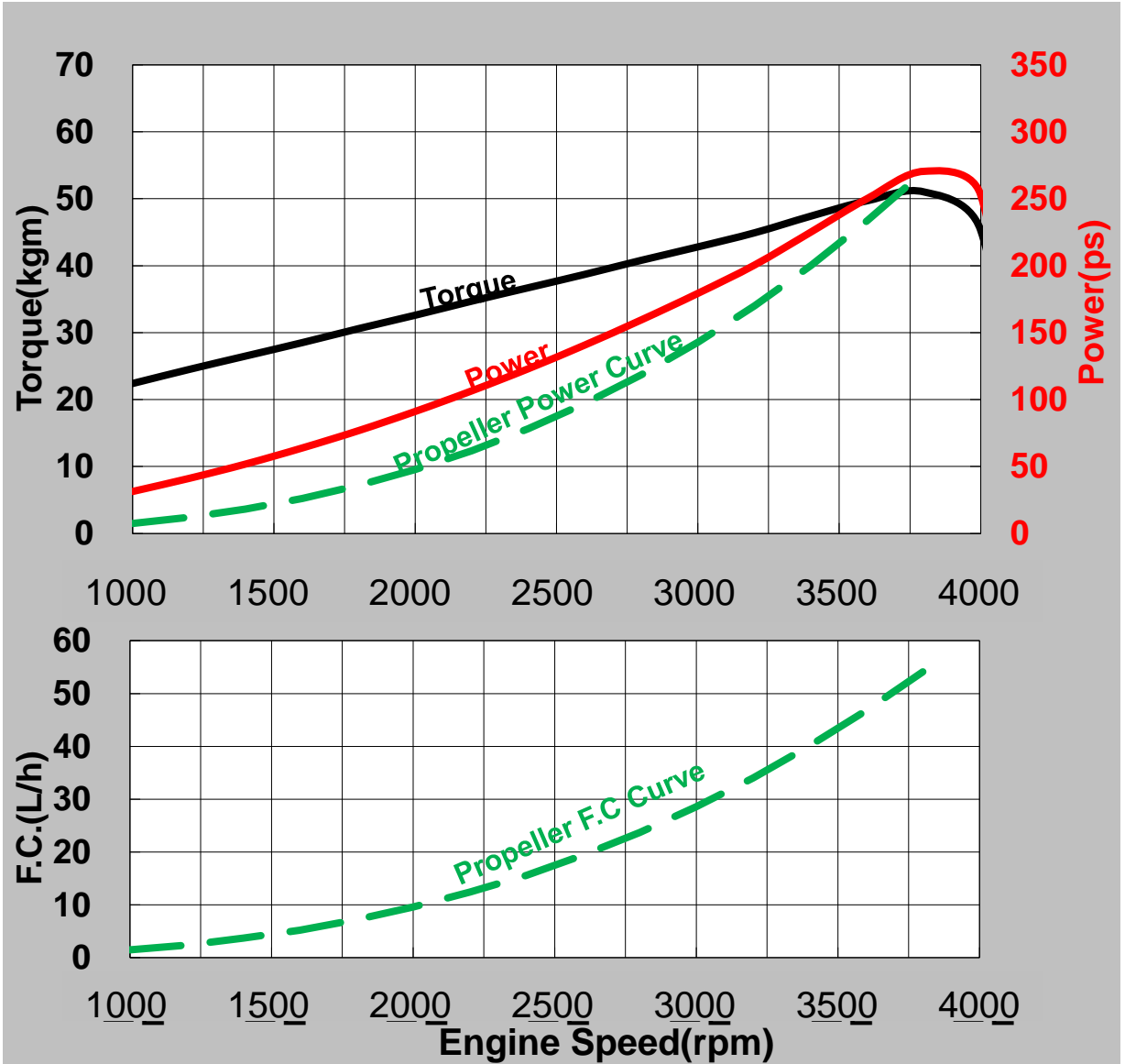

*F.C : Fuel Consumption



7. BELT INSTALLATION & ENGINE DIMENSIONS

▪ V-RIBBED BELT INSTALLATION

MODEL : S2-ENG SERIES	
AN	ALTERNATOR
DP	DRIVE PULLEY
IP	IDLER PULLEY
PS	POWER STEERING
TP	TENSIONER PULLEY
WP	WATER PUMP PULLEY

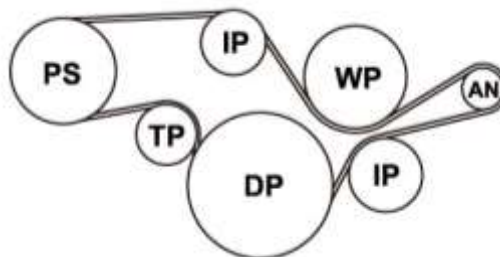

▪ MerCruiser Bravo One X Diesel

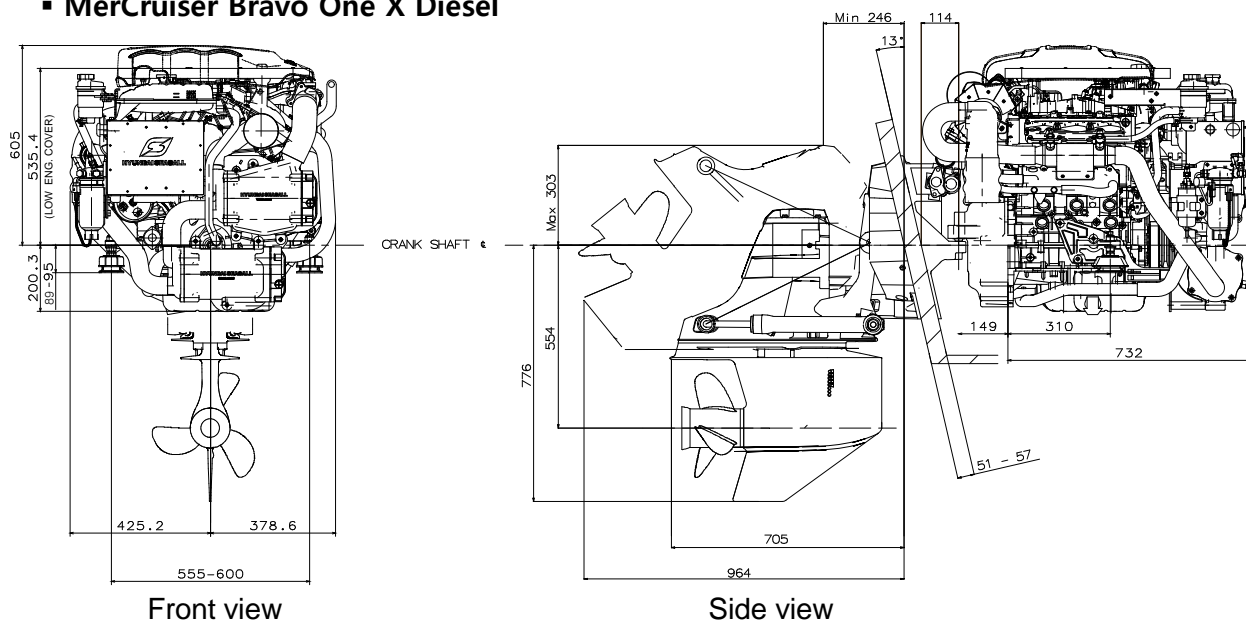

▪ MerCruiser Bravo Two X Diesel

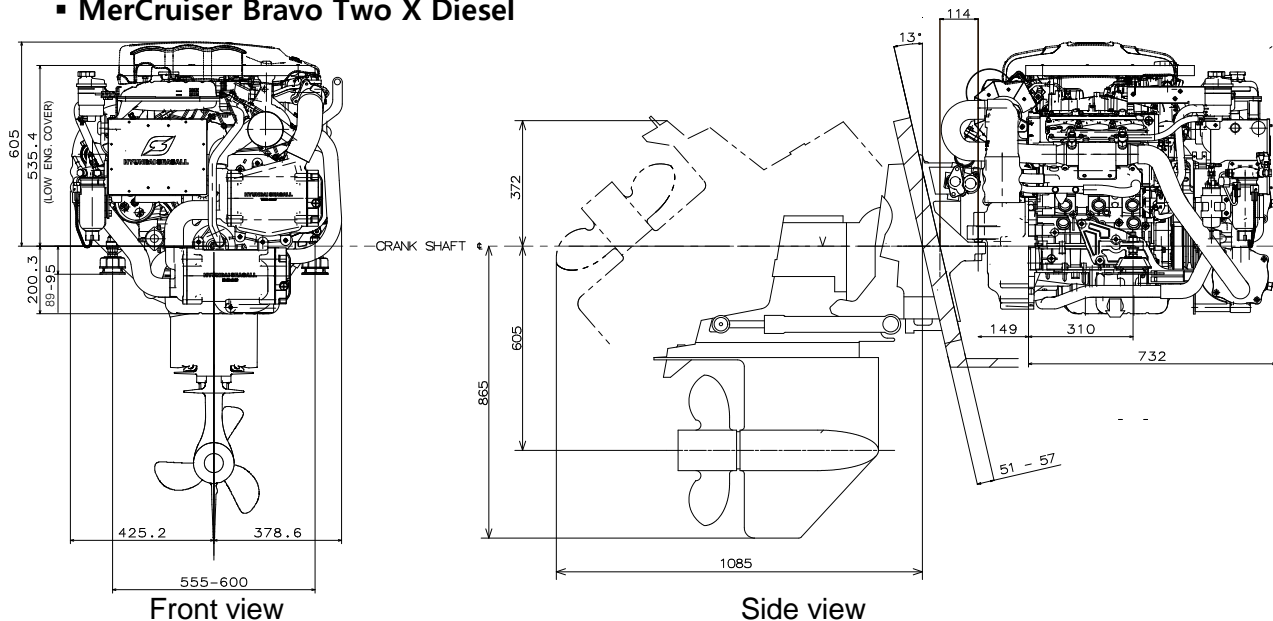



MerCruiser Bravo Three X Diesel

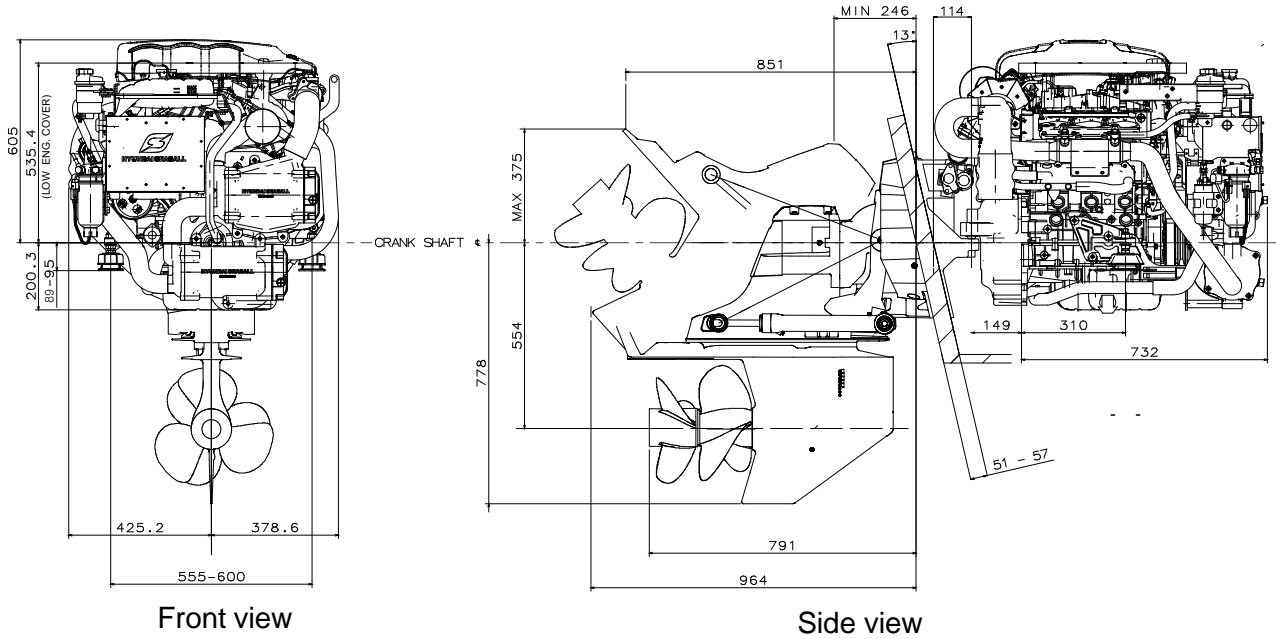

Front view

Side view

ZF 63 A

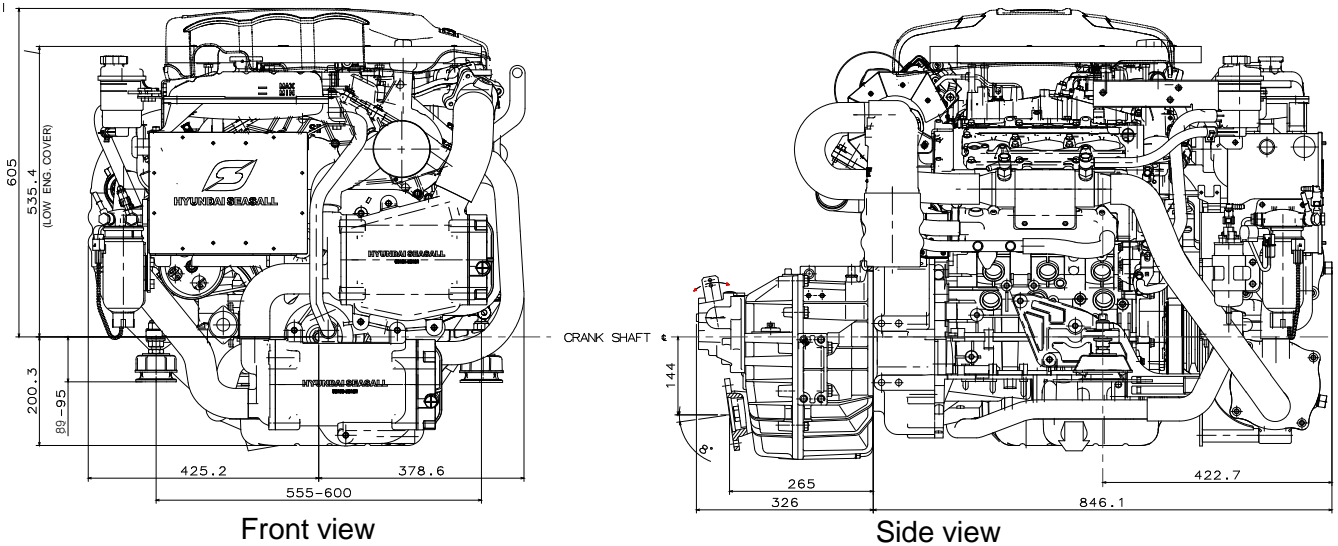

Front view

Side view



INSTALLATION & OPERATION MANUAL

S270 Series Engines

▪ ZF 63 C

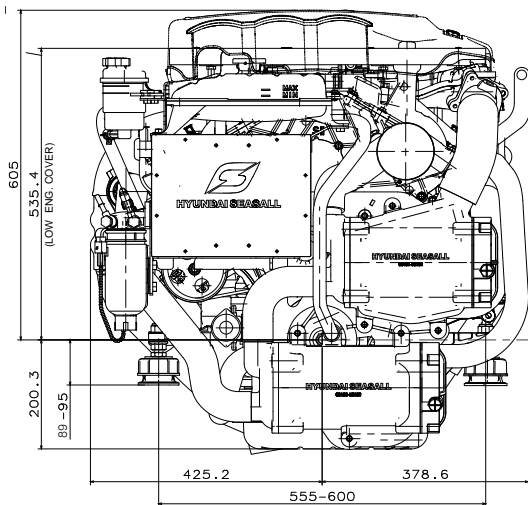

Front view

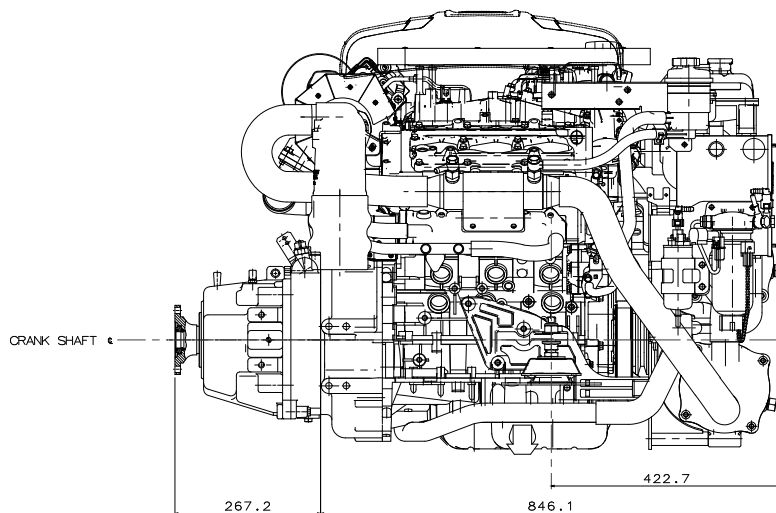

Side view

▪ Waterjet adapter without ZF 63 C

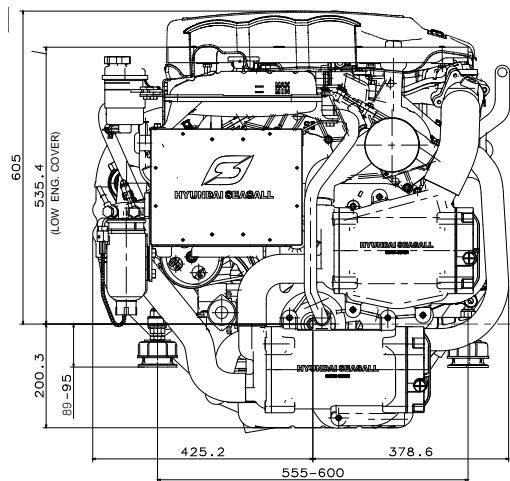

Front view

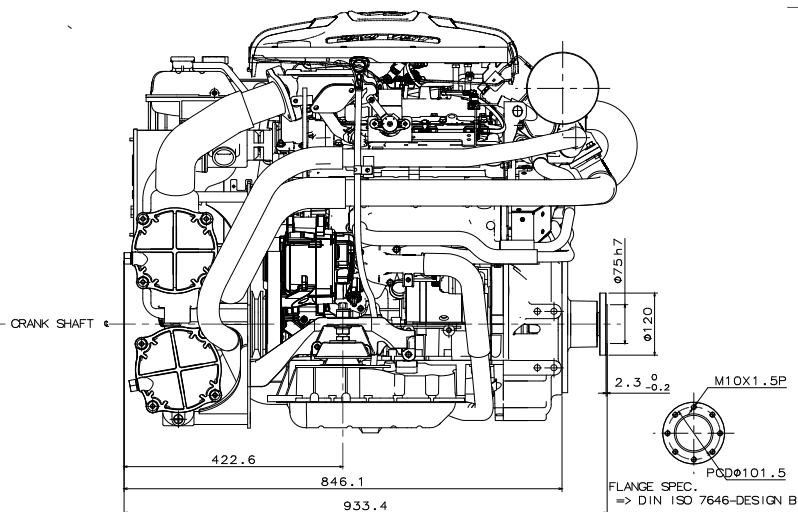

Side view

CHAPTER 2
ENGINE MOUNT SYSTEM

1. PREPARING THE ENGINE INSTALATION

- It is essential that the engine bed is perfectly flat before using the engine mount tool.
- Make sure that the rubber engine mounts are installed so that no pre-load or side forces occur when the engine has been installed and aligned with the stern drive

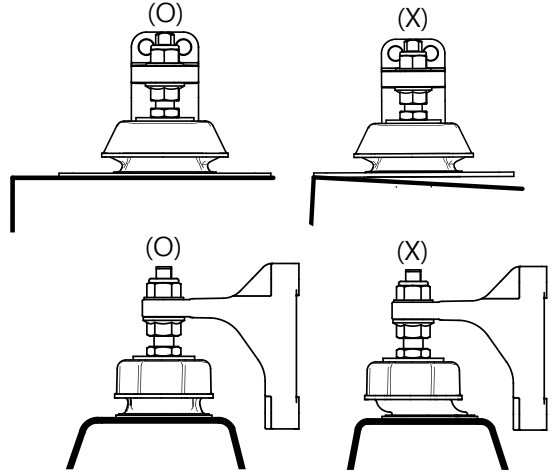

1.1 CHECK THE MOUNT HOLE

- Mark 'R': Mount hole for R200S
- Mark 'S': Mount hole for S270S & S250S
- Mark 'U': Mount hole for U125S
- Mark 'D': Mount hole for D170S & D150S

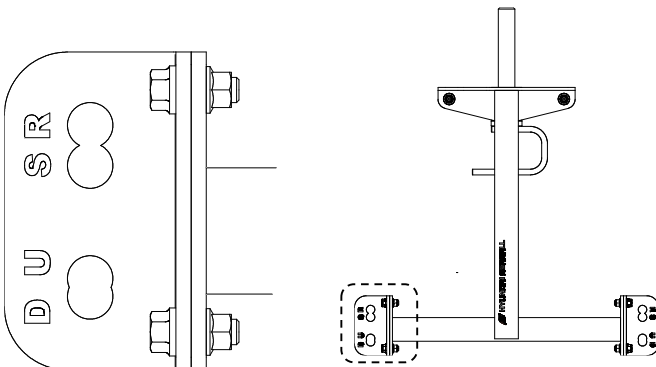

<Engine mount tool>

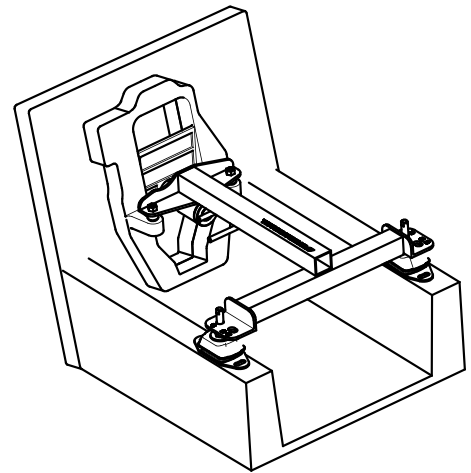

<Check the position of the engine mounts >

- Engine installation must be done by a qualified technician. Hyundai SeasAll engines must be aligned using the genuine Hyundai SeasAll alignment tool. Otherwise the drive coupler will be damaged.



< Hyundai-SeasAll alignment tool(5 Step) >



< MerCruiser alignment tool(4 Step) >

1.2 CHECK THE MOUNT BED

- To avoid the interference with engine parts, below dimension is should be considered.

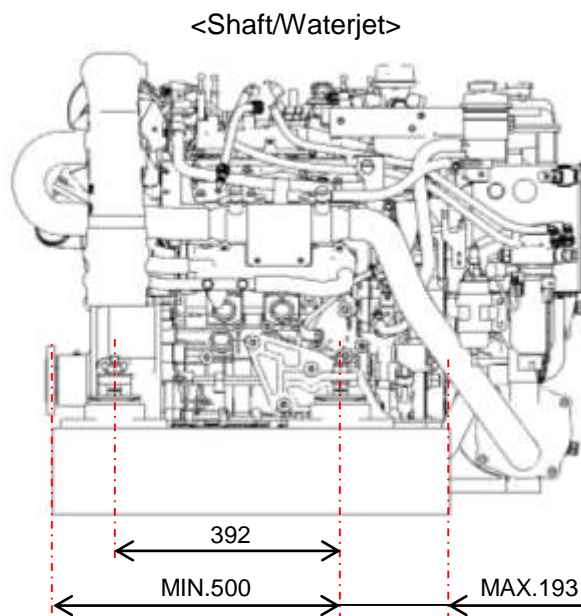
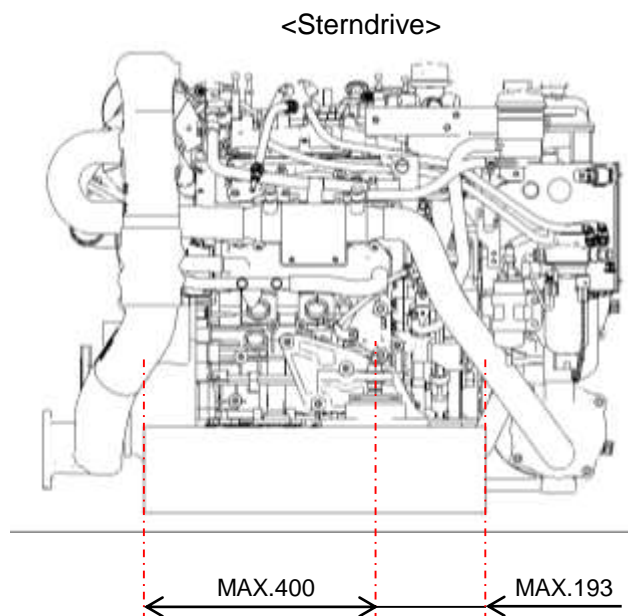
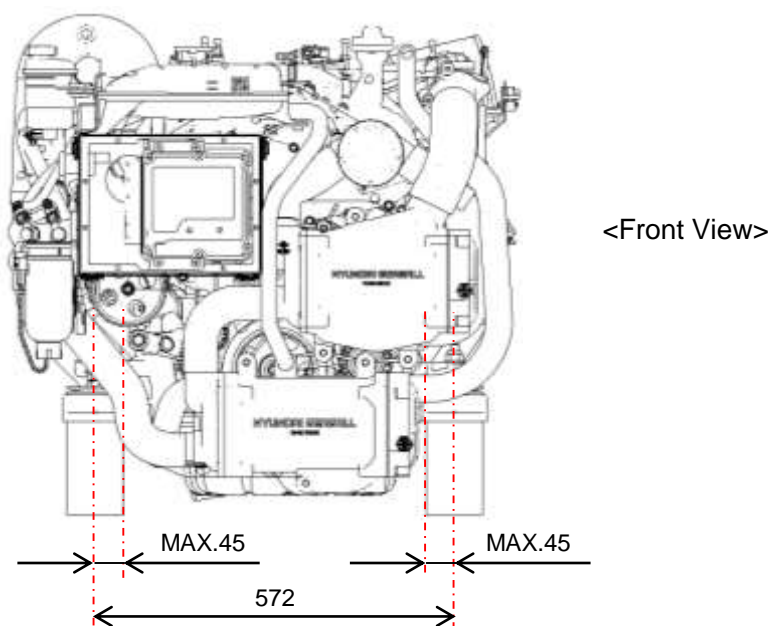

<Right Side View>

* Left side view is needed same dimension



INSTALLATION & OPERATION MANUAL

S270 Series Engines

2. BELLHOUSING FIXING

- Assemble exhaust pipe after tightening the mounting bolts between bell housing and transom plate. Use the following parts:

- 1 Mounting Bolt
- 2 Washer
- 3 Spacer
- 4 Fiber Washer
- 5 Nut

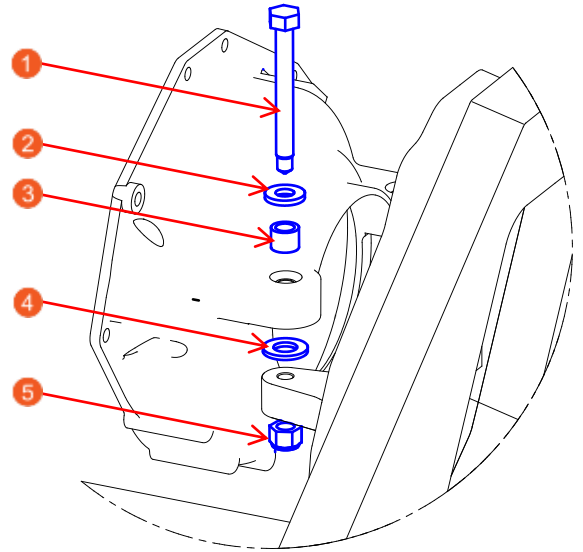

3. ASSEMBLING ENGINE MOUNTS

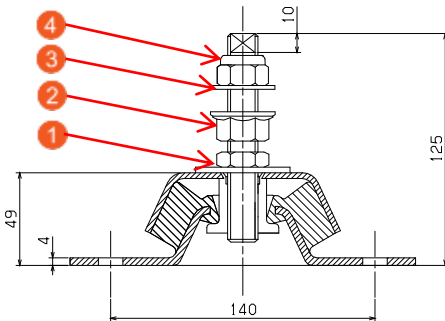

WARNING
DON'T USE THE SPRING WASHER.
IF YOU USE SPRING WASHER, THE PROBLEM OF
ENGINE ALIGNMENT CAN BE OCCURRED.

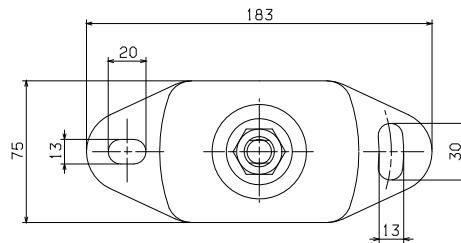

1) To prevent twisting the engine mount during engine alignment, use a spanner on the lower nut (1) to keep the bolt from turning while adjusting the engine height by turning the middle nut (2). Adjust the engine height until the Hyundai SeasAll alignment tool can be properly inserted.

2) After alignment, place washer (3) on top of engine support bracket and tighten lock nut (4) while keeping the middle nut (3) from turning with a spanner.

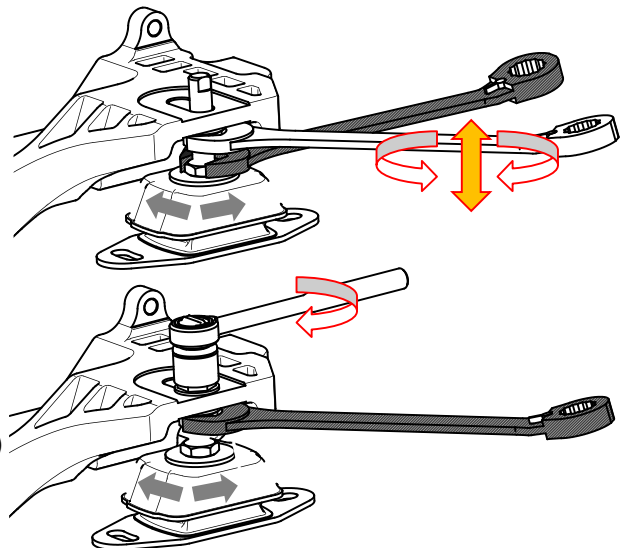

CHAPTER 3

COOLING SYSTEM & EXHAUST SYSTEM

1. SCHEMATIC DIAGRAM OF ENGINE COOLING CIRCUIT

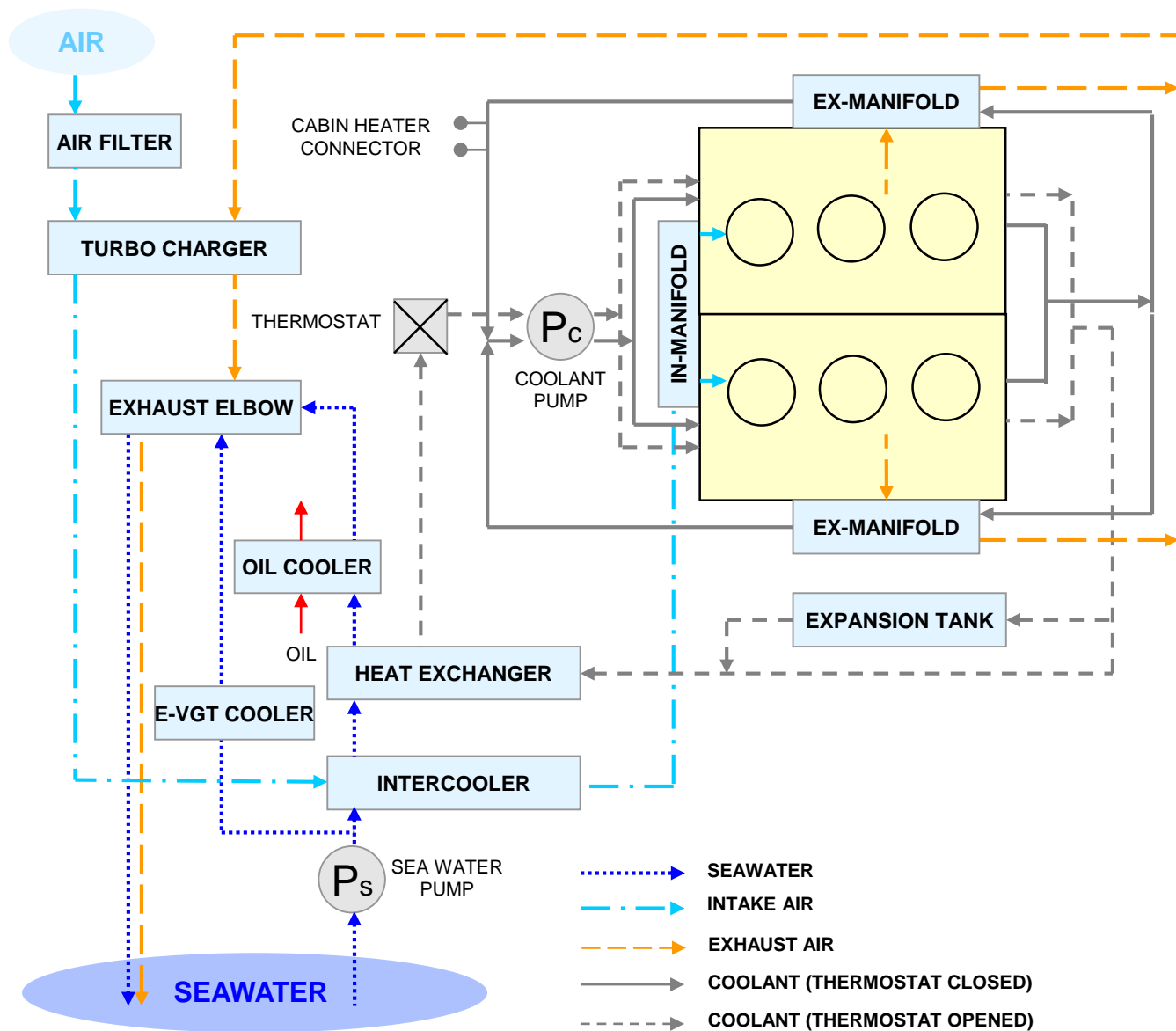



2. SEAWATER FLOW – OPEN COOLING CIRCUIT

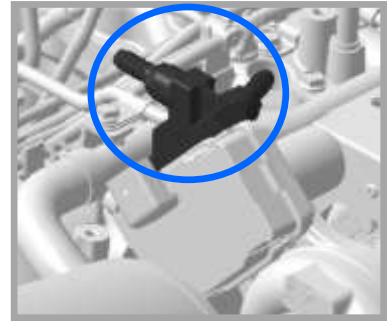
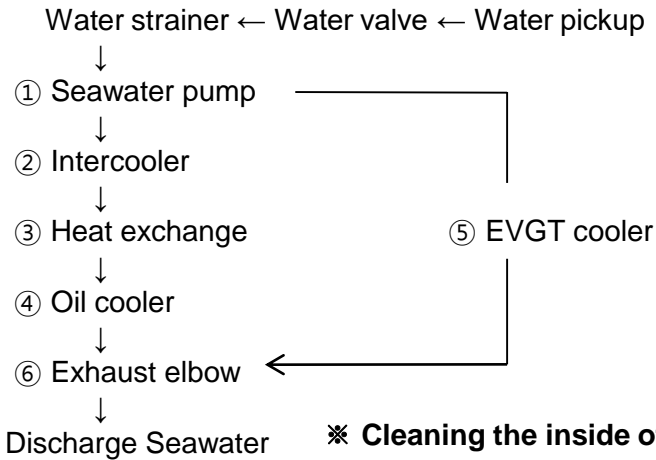

EVGT cooler

※ **Cleaning the inside of the cooler every 250 hours or every year.**

2.1 WATER PICKUP

- 1) Water pickup should be installed in an area where it won't pick up air bubbles and will access clean water during all phases of the engine operation.
- 2) After start up, you must check for air bubbles by inspecting the waterline. Bubbles will appear if there is a leakage from the waterline. If bubbles appear, leakage area must be detected and completely sealed prior to engine operation.
- 3) For sterndrive models, please see the section "Installing Sterndrive Seawater Pickup" of the Bravo Sterndrive Installation Manual included in the original packaging.
- 4) For further safety, you must install an additional transom or bottom mounted clamshell-type water pickup. Water flow from the Bravo sterndrive leg only is not adequate to provide proper engine cooling.

2.2 WATER STRAINER

- 1) Strainer should be located in an area where it will be easily accessible for periodic seawater flow inspection and cleaning.
- 2) The size of strainer must be of sufficient capacity to pass the seawater (a minimum flow rate over 200 liters per minute).
- 3) Strainer must be installed after water inlet valve in order to allow user to shut off seawater when cleaning strainer filter.

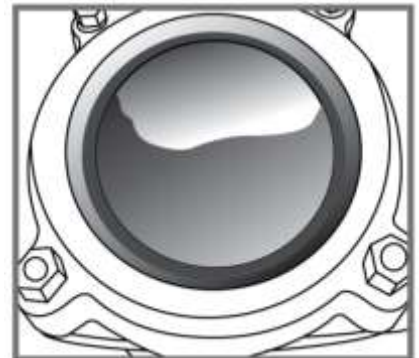

CAUTION

IF THE SEAWATER STRAINER IS NOT PROPERLY ASSEMBLED, AIR CAN BE SUCKED INTO THE COOLING CIRCUIT, DISTURBING THE VACUUM PROCESS. THIS CAN CAUSE THE ENGINE TO OVERHEAT.

4) To clean strainer filter,

- Stop the engine and close the water valve
- Remove the filter cap
- Remove the filter element, flush it thoroughly with clean water or compressed air
- Insert the cleaned filter element and screw on the filter cap
- Check the cap and the gasket for correct seating and sealing
- Open the water valve
- Start the engine and check if there is water leakage

2.3 SEAWATER PUMP

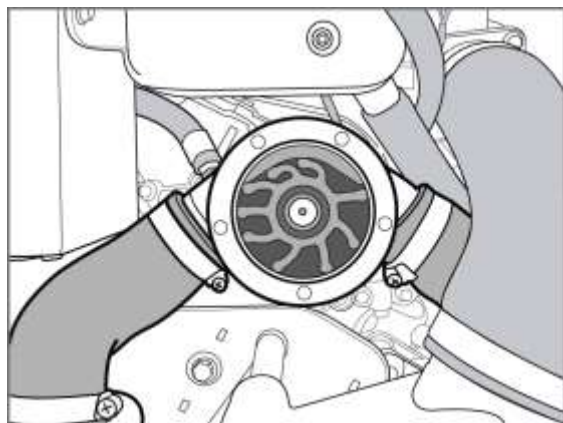
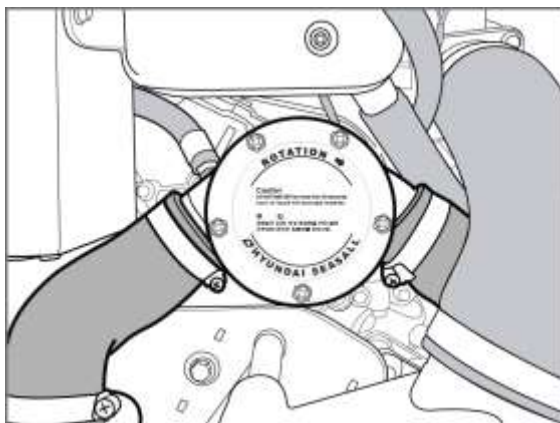

- The internal diameter of the hose connected to seawater pump inlet should be 45~46mm.
- The cross section of the hose may shrink due to inlet pressure drop. Therefore, the hose from water pickup in the boat's hull to the seawater pump inlet should be as short as possible and must be made of steel wire reinforced material.
- The seawater pump impeller must be checked periodically and replaced if necessary.

CHECKING SEA WATER PUMP & IMPELLER

- Stop the engine and close the water valve
- Remove the impeller housing cover
- Remove the impeller from inside the seawater pump
- Check the condition of impeller and bushing
- Apply soapy water to impeller when assembling, and reassemble towards rotation direction
- Replace of the O-ring on the impeller housing cover
- Open the water valve
- Start the engine and check if there is water leakage



CAUTION

IF THE SEAWATER STRAINER IS NOT PROPERLY ASSEMBLED, AIR CAN BE SUCKED INTO THE COOLING CIRCUIT, DISTURBING THE VACUUM PROCESS. THIS CAN CAUSE THE ENGINE TO OVERHEAT.



CAUTION

DO NOT RUN THE ENGINE WITHOUT SEAWATER. THE SEAWATER PUMP IMPELLER WILL BE DAMAGED. BEFORE STARTING THE ENGINE, BE SURE TO SUPPLY SEAWATER TO THE PASSAGES.



CAUTION

IMPELLER DAMAGE MAY OCCUR IF APPROPRIATE TOOLS ARE NOT USED WHEN REMOVING THE IMPELLER. MAKE SURE TO CHECK O-RING CONDITION AFTER SEAWATER PUMP REASSEMBLY.



CAUTION

DO NOT INSTALL ADDITIONAL DEVICES WHICH COULD OBSTRUCT THE FLOW OF SEAWATER. THIS CAN CAUSE THE ENGINE TO OVERHEAT.

3. ENGINE COOLANT FLOW – CLOSED COOLING CIRCUIT

▪ THERMOSTAT CLOSED CONDITION

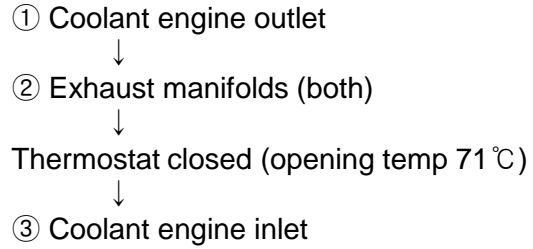
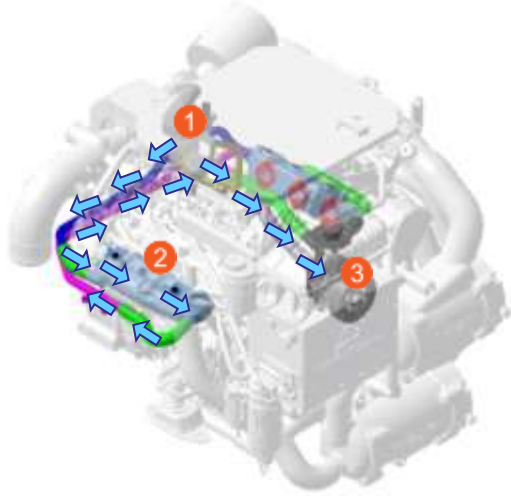

▪ THERMOSTAT OPENED CONDITION

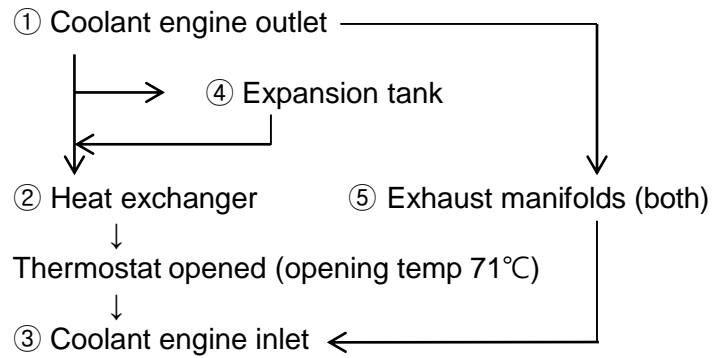
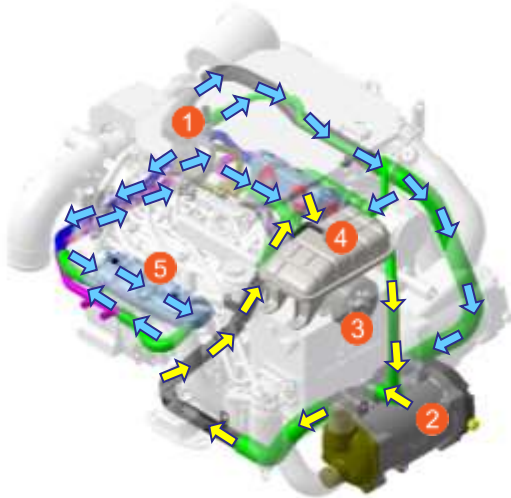

3.1 ENGINE COOLANT

- 1) The high-pressure cooling system has a reservoir filled with year-round antifreeze coolant. The reservoir is filled at the factory.
- 2) The coolant level should be between MAX and MIN marks on the side of the coolant reservoir when the engine is cool.

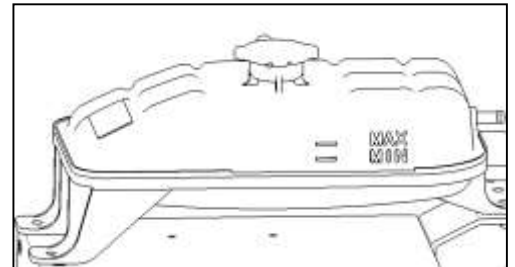

- 3) If the coolant level is low, add enough specified coolant to provide protection against freezing and corrosion. Bring the level to MAX, but do not overfill.
- 4) If frequent additions are required, see an authorized dealer for a cooling system inspection.
- 5) Use only soft (demineralized) water in the coolant mixture.
- 6) The engine has aluminum engine parts and must be protected by an ethylene-glycol based coolant to prevent corrosion and freezing.
- 7) DO NOT USE alcohol or methanol coolant or mix them with the specified coolant.
- 8) DO NOT USE a solution that contains more than 60% antifreeze or less than 35% antifreeze, which would reduce the effectiveness of the solution.
- 9) For mixture percentages, refer to the following table:

Ambient Temperature	Mixture Percentage(volume)	
	Antifreeze	Water
-15°C°(5°F)	35	65
-25°C°(13°F)	40	60
-35°C°(31°F)	50	50
-45°C°(49°F)	60	40

- 10) In order to drain engine coolant, please use a screwdriver to loosen the drain plug
 ①.The drain plug is located under the heat exchanger unit.

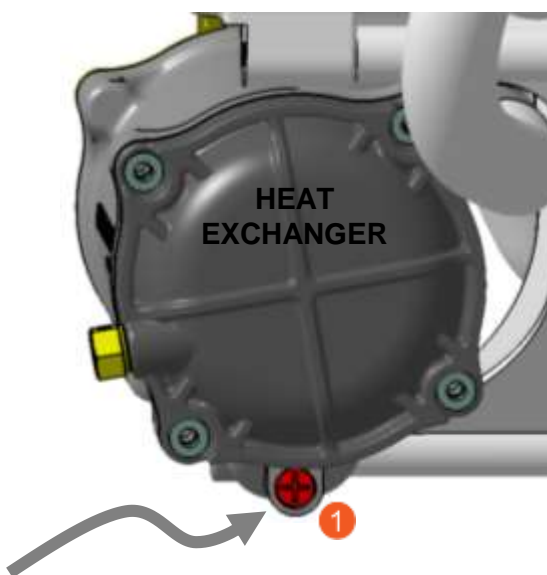

ENGINE COOLANT DRAIN PLUG

3.2 REMOVING AIR BUBBLES IN COOLANT LINE

- 1) Start the engine and warm it up at a low rpm (up to thermostat opening)
- 2) Next, stop the engine and allow the engine to cool enough, and then open the cap of the expansion tank carefully.
*NOTE: Never open the cap when the engine is hot. Doing so may cause scalding.
- 3) Refill with coolant if needed.
- 4) Recap the expansion tank.
- 5) Please check the level of expansion tank regularly while driving.

3.3 CABIN HEATER CONNECTION

- 1) In order to use cabin heater, an extra coolant circulation pump is needed.
- 2) After connecting cabin heater lines, engine coolant must be refilled and checked.
- 3) Please check coolant flow direction, as shown in the figure.
- 4) If in doubt, please contact your nearest Hyundai SeasAll dealer.

*After installing a cabin heater and refilling the system, the coolant in the coolant expansion tank may initially overflow.

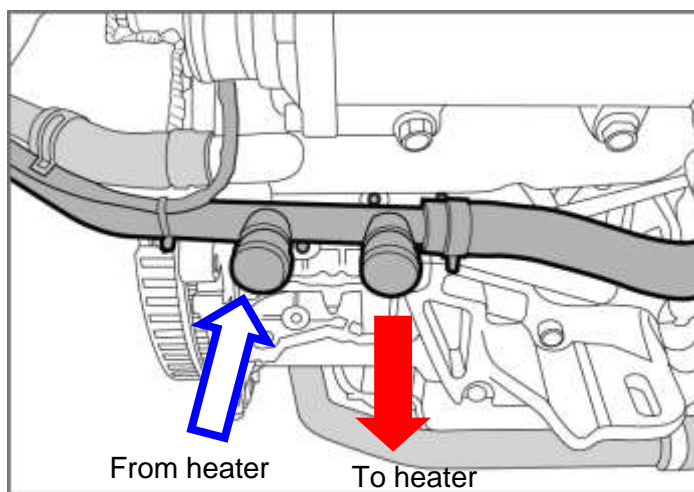

* Outer diameter of pipe is $\varnothing 17.3$ mm



WARNING

NEVER OPEN THE EXPANSION TANK CAP WHEN THE ENGINE IS OPERATING OR HOT. IT MAY CAUSE ENGINE DAMAGE AND COULD RESULT IN SERIOUS PERSONAL INJURY.

4. EXHAUST SYSTEM

- 1) Your Hyundai SeasAll engine's exhaust system consists of a coolant-cooled exhaust manifold and a seawater-cooled exhaust elbow (water injected wet exhaust system).
- 2) The vessel's exhaust pipe line should not be made too long or to bend. The maximum back pressure of the exhaust gas should be under 50kPa.
- 3) Make sure that the shortest height between bottom of the exhaust elbow and the center of the crank axis is 36cm.
- 4) If the distance between the bottom of the exhaust elbow and the waterline is less than 15cm, or if the waterline is above the water injection point, there is a risk of flowing back (siphoning by engine stopping and outside seawater entering through the transom exhaust hole).
- 5) In order to avoid this risk, a vacuum breaker and exhaust riser are needed. If in doubt about exhaust system installation, please contact your nearest Hyundai SeasAll dealer.

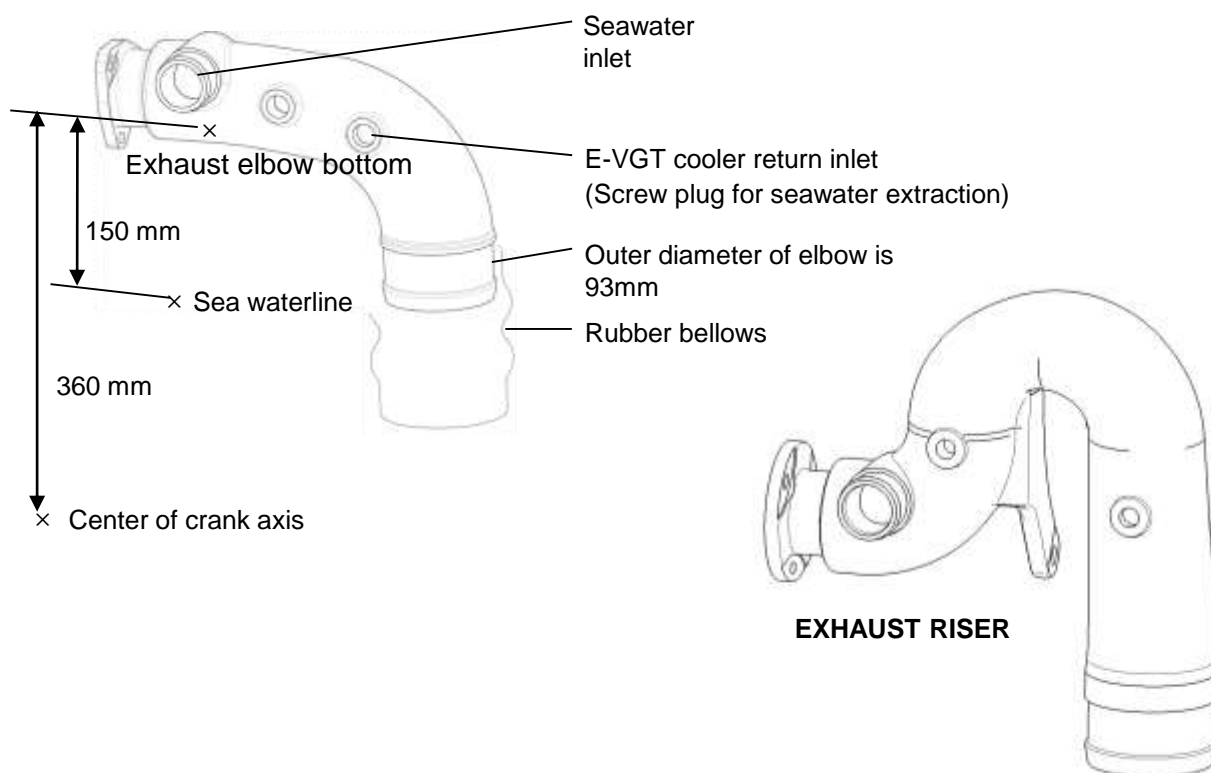

CAUTION
 IF IN DOUBT ABOUT EXHAUST SYSTEM INSTALLATION, PLEASE CONTACT YOUR NEAREST HYUNDAI SEASALL DEALER.

CHAPTER 4 FUEL SYSTEM

The fuel supply system of this engine is diesel common rail direction injection. In order to optimize engine combustion, its maximum injection pressure is up to 1800 bar. Multi-injection is possible thanks to the quick response of the piezo type injector.

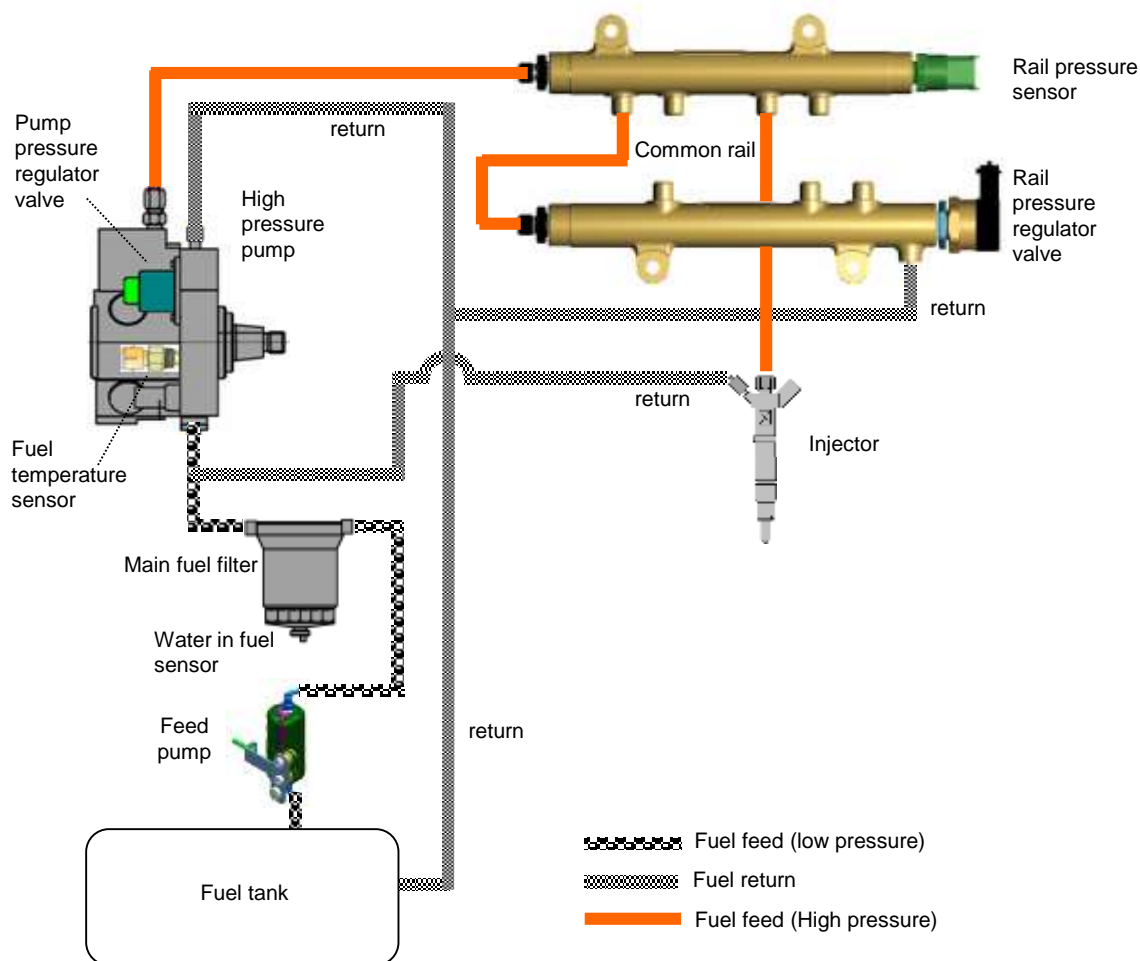



INSTALLATION & OPERATION MANUAL

S270 Series Engines

1. FUEL FLOW

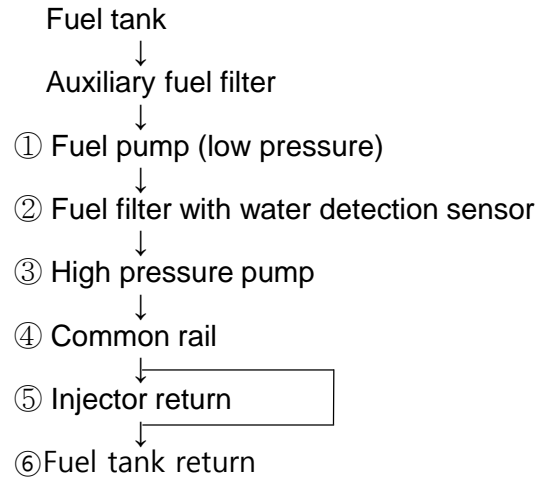
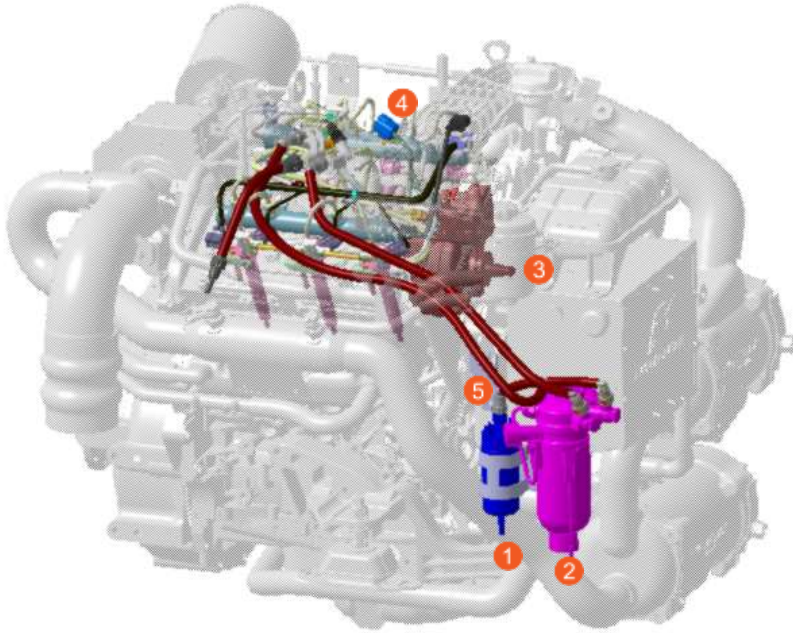

2. LOW PRESSURE FUEL LINE

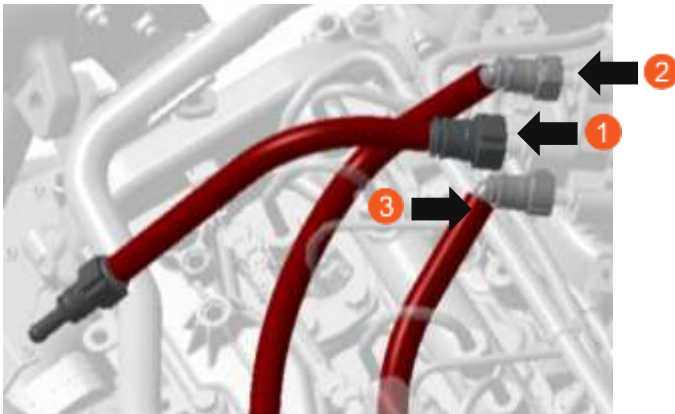

- ① Return line to fuel tank (engine out)
- ② Return line from injector to main fuel filter (engine out)
- ③ Feeding line from main fuel filter
- ④ Feeding line from fuel tank to electric feed pump (low pressure pump)
- ※ The internal diameter of all fuel lines must be at least 8 mm.

3. ACCELERATION SENSOR AND CONTROL LEVER

When installing control lever cable to acceleration sensor, be sure that the acceleration sensor lever is fully released to the idle position and fully pulled to the full-load position. The swing distance of lever between idle and full-load position is 60mm.

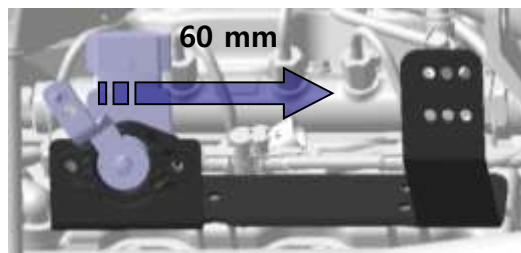

The procedures for control lever installation

1) Idle position setting

Make sure that the position value (%) should indicate 0% at neutral condition.

2) Full load position setting

Make sure that the position value (%) should indicate full load range (90~99.2%) at fully forward lever condition. If not adjust sleeve of control cable



CAUTION

YOU SHOULD PERFORM ABOVE PROCEDURES AFTER CONTROL LEVER INSTALLATION WHEN ENGINE IS NOT RUNNING BUT IGNITION KEY IS ON.

4. RECOMMENDED FUEL QUALITY

The following fuels should be used for engine operation:

- Standard summer / winter diesel fuel according to DIN EN 590 (classes A-F)
- Diesel fuel according to DIN EN 590 (classes 0-4) in arctic climates
- Summer diesel fuel according to California and U.S. federal regulations
- Winter diesel fuel if lubricity is comparable to diesel fuel according to DIN EN 590
- Mixture of diesel fuel with 5 Vol.% RME according to DIN 51606
- Later admixing or additional use of additives, gasoline or special fuels is not permitted

5. DRAINING WATER FROM FUEL FILTER

- 1) The fuel filter for a diesel engine plays the important role of separating water from fuel and accumulating the water in its base. If water accumulates in the fuel filter, a warning light comes on when the ignition switch is in the ON position.
- 2) If the water in the fuel filter is over the limit, the Water Sensor Lamp on the EOI will light up. If this happens, you must stop the engine and drain the water in fuel filter yourself or ask the nearest workshop to do this.
- 3) Water and a little fuel will drain at the same time. Therefore, avoid flames in your workspace.
- 4) If your fuel is not well suited to your engine, more frequent drainage will be required.
- 5) To check and drain the water in fuel filter:

- Loosen the drain plug (part ①) and drain water. 100 ~ 200cc drainage is proper
- After water is drained, securely tighten the drain plug
- After starting the engine, check to make certain the fuel filter warning light is off



CAUTION

HYUNDAI SEASALL'S GUARANTEES OR WARRANTIES ARE VOID IN CASES WHERE DAMAGE TO THE FUEL INJECTOR COMPONENTS (HIGH PRESSURE PUMP, INJECTORS, ETC.) CAN BE ATTRIBUTED TO THE USE OF UNQUALIFIED FUELS.

IF THE WATER ACCUMULATED IN THE FUEL FILTER IS NOT DRAINED AT PROPER TIMES, DAMAGE TO MAJOR ENGINE PARTS WILL OCCUR. WHEN REPLACING THE FUEL FILTER CARTRIDGE, USE GENUINE PARTS ONLY.

CHAPTER 5
AIR INTAKE SYSTEM

1. ENGINE AIR CONSUMPTION

-. The engine needs to have a proper volume of intake air for combustion. This requires a minimum internal area of air supply ducting the area can be calculated by using the following formula:

A = cross section of area in cm²

A = 1.9 X Engine power (KW)

→ A = 1.9 X 199 (KW) = 378.1cm² = Ø 21.95cm

Area = π r². 378.1 / π (3.14) = 120.

Square Root of 120 = 10.95 = radius. 2 x radius = diameter (21.95)

Number of pipe bends (90°)	Length of pipe (Meters)				
	1	2	3	4	5
1	1	1.04	1.09	1.13	1.20
2	1.39	1.41	1.43	1.45	1.49
3	-	1.70	1.72	1.74	1.78

Minimum intake area is **Ø21.95cm**. When use longer ducts or more bends are used the area is corrected by multiplying by coefficient from the table above. We recommend to position the air inlet around 25~35cm from the air filter. The air inlet must never be installed in the transom as water and/or exhaust gases could be ingested.

Example) Length of pipe : 3M , number of pipe bands : 2

→ Ø21.95cm X 1.43 = Ø31.38cm

※ **Minimum Bending Radius = 2 X O.D of pipe (90° case)**

2. ENGINE ROOM VENTILATION

-. Engine room needs proper ventilation for optimum engine operation. This requires a minimum internal area of air ventilation. The area can be calculated by using the formula:

A = 1.65 X Engine power (KW)

→ A = 1.65 X 199 (KW) = 328.3cm² = Ø20.45cm

-. Minimum ventilation area is **Ø20.45cm**, when using longer ducts or more bends are used the area is corrected by multiplying by coefficient from the table above. **The air inlet and outlet vents should be the same size.** The distance between air inlets and air outlets should be as far as possible from each other. If the distance is too short, air will not circulate properly which will result in bad ventilation. **A blower should be installed** in the exhaust air duct to ventilate and cool the engine room more effectively.

Extraction fan capacity (Air Flow m³/min) = 0.07 X Engine power (KW)

→ **Extraction fan capacity = 0.07 X 199 (KW) = 13.9m³/min**

※ **General pressure drop of Engine room = 0.1~0.5kPa**

Example) Length of pipe : 3M , number of pipe bands : 2

→ Ø20.45cm X 1.43 = Ø29.24cm

3. AIR FILTER MAINTENANCE

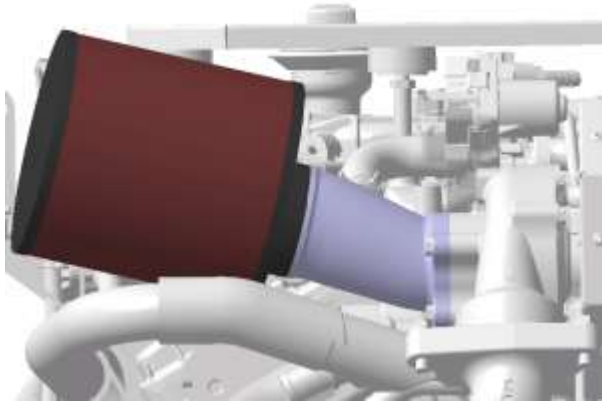

- The original Hyundai SeasAll air cleaner may be cleaned and reused.
- If the air filter is very dirty, it can increase airflow resistance and reduce flow of air to the engine. This can result in reduced power and fuel efficiency.
- Cleaning the air filter should be carry out periodically according to the procedure below.
- Do not clean the filter element with gasoline or other solvent cleaners.
- Remove the air filter from engine.
- Put the air filter on a flat surface and shake dust out.
- Liberally spray K&N Air filter Cleaner onto both sides the of filter and allow to soak for 10 minutes to loosen the dirt.
- Wash out the dust with low pressure running water from the inside toward the outside.
- Dry the wet air filter in the shade for 2~3 hour. You can reduce drying time by blowing with a hair dryer on COLD or by blowing with low pressure compressed air.
- (CAUTION) Do not use high pressure air, high pressure water or hot air to clean and/or dry the air filter. These can damage the performance of the air filter.
- Apply air cleaner oil over the outside of the filter. If too much oil is applied, it will reduce performance.
- Reassemble air filter to engine.



CAUTION

WHEN REMOVING THE AIR FILTER, BE CAREFUL THAT DUST OR DIRT DOES NOT ENTER THE AIR INTAKE, OR DAMAGE MAY RESULT. DO NOT RUN WITHOUT AIR CLEANER. THIS COULD RESULT IN EXCESSIVE ENGINE WEAR. USE OF NON-GENUINE PARTS COULD DAMAGE THE TURBO CHARGER OR ENGINE.

CHAPTER 6
LUBRICATION SYSTEM

1. ENGINE OIL FLOW

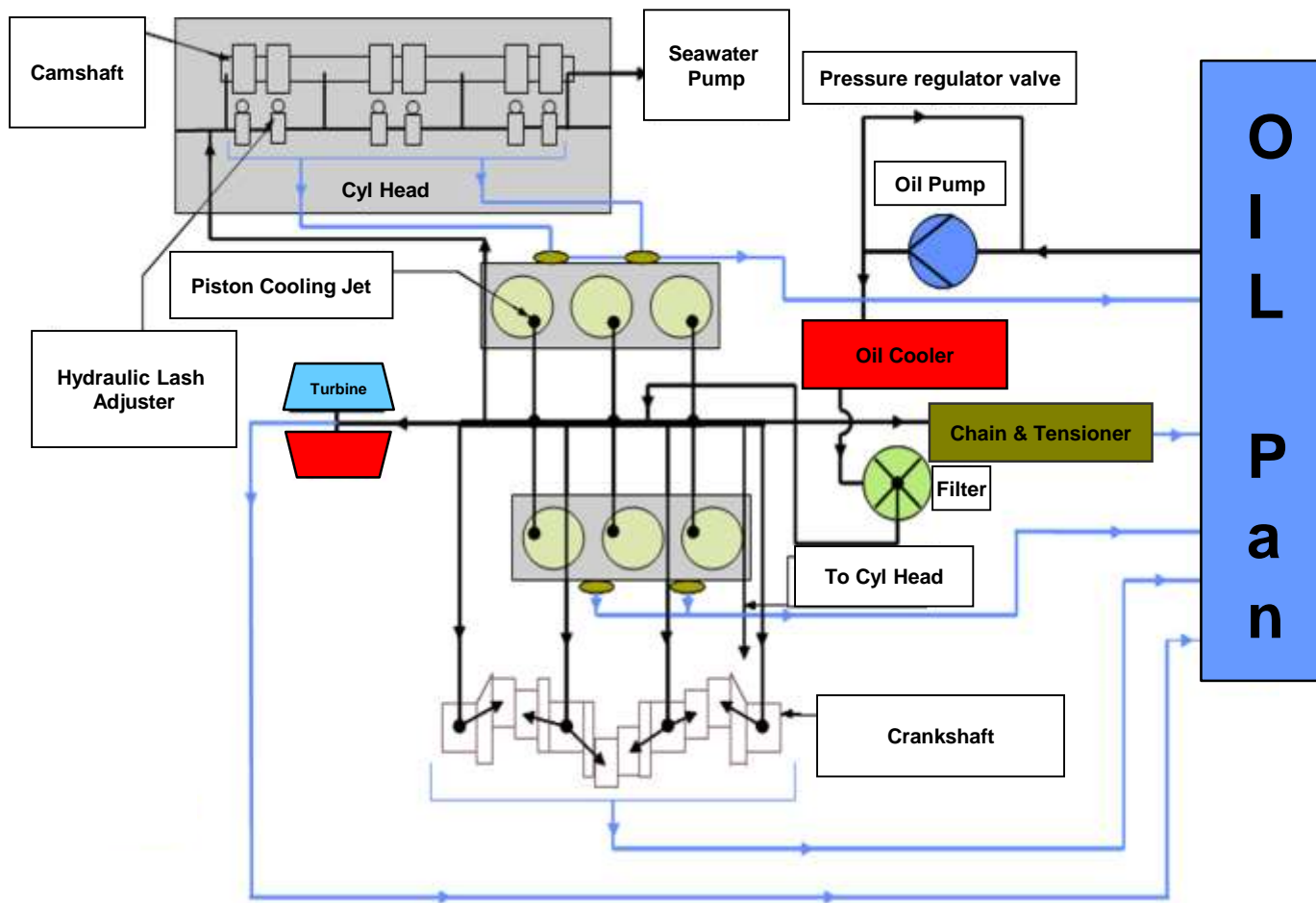

→ Supply
→ Return

2. ENGINE OIL LEVEL CHECKS

- The engine oil level must be checked at regular intervals.
- Be sure the boat is level.
- Start the engine and allow it to reach normal operating temperature.
- Turn the engine off and wait about 5 minutes, until the oil has returned to the oil pan.
- Pull the dipstick out, wipe it clean, and re-insert it fully.
- Pull the dipstick out again and check the level. The level should be between F and L. If it is near or at L, add enough oil to bring the level to F. Do not fill with engine oil above the F mark.

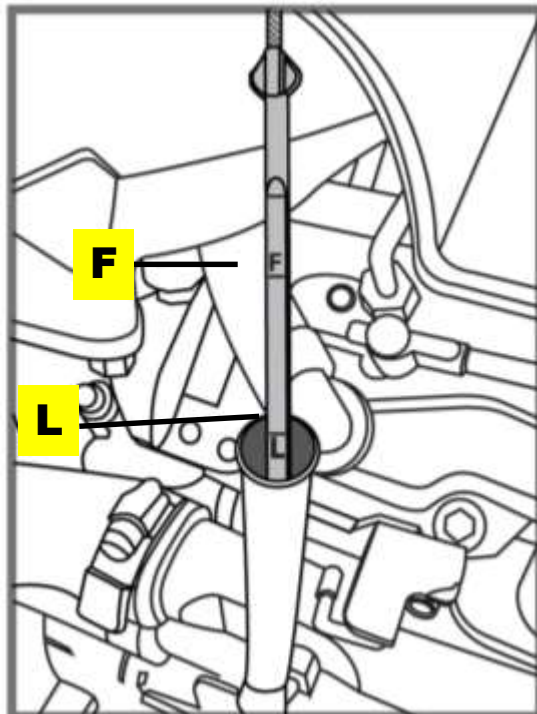

3. RECOMMENDED OIL QUALITY

For best performance and maximum protection during all types of operation, select only those lubricants which :

- 1) Satisfy the requirement of the API or ACEA classification.
- 2) Have proper SAE grade number for expected ambient temperature range.

Description		Specifications	Limit
Oil quality	ACEA	Above B4	Service oil quality should conform to ACEA or API classification.
	API	Above CH - 4	
	SAE	15W-40	-15°C above
		10W-30	-20°C ~ 40°C
		5W-30	-25°C ~ 40°C
	0W-30	10°C below	



4. ENGINE OIL EXTRACTION PUMP

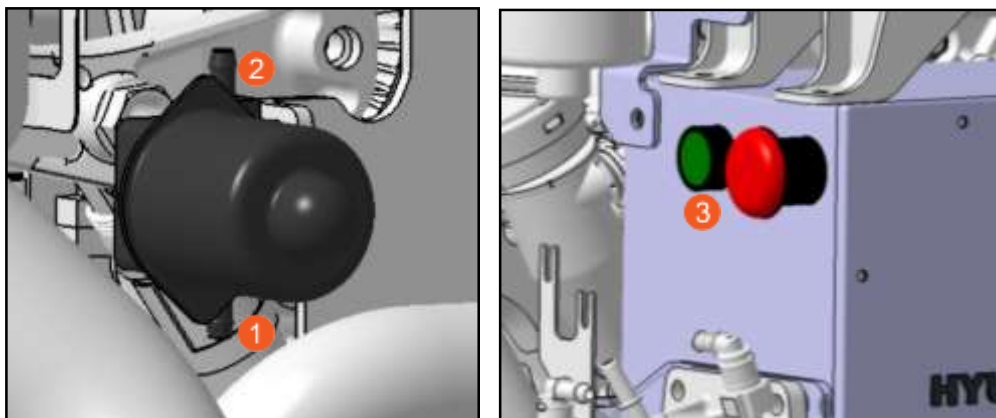

- 1) Allow the engine to warm up at least 5 minutes.
- 2) Remove the engine oil inlet cap and oil filter.
- 3) The oil drain hose is connected to the oil extraction pump ①, route the loose end of the hose into the container being used for the oil change ②.
- 4) Turn the ignition key ON (but do NOT start the engine) then press and hold button ③ on the left side of the ECU box with the ignition switched on until the engine oil is completely pumped out.

5. OIL FILTER REPLACEMENT

- 1) Remove the oil filter cap by using a 32mm wrench; loosen the oil filter cap slowly. Be careful not to drop engine oil while the oil filter paper is removed with its cap.
- 2) Remove the oil filter element (A) and its O-ring (B) from its cap.
- 3) Replace the filter element assembly and O-ring with the new ones that are supplied as a service kit. Do not reuse the removed O-ring.
- 4) Assemble the oil filter cap with the filter fixed. The tightening torque is 24.5Nm (2.5kgf·m, 18.1lb-ft).

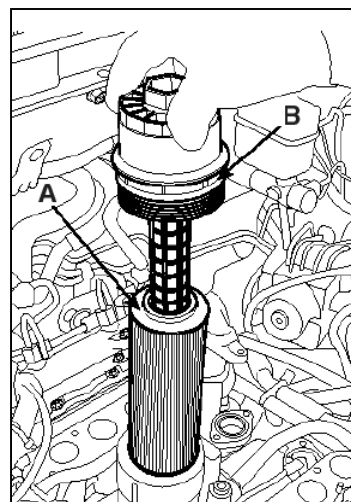

WARNING

USED OIL MUST BE STORED IN A SAFE PLACE AWAY FROM CHILDREN AND SOURCES OF IGNITION. IF YOU HAVE A USED OIL DISPOSAL PROBLEM, PLEASE HAVE THE ENGINE OIL CHANGED BY YOUR NEAREST HYUNDAI SEASALL SERVICE DEALER.

CHAPTER 7
ELECTRICAL SYSTEM

1. BATTERY CABLE CONNECTIONS

- 1) The size of battery cable should be at least 40mm² and no longer than 4m.
 - 2) If the cable is longer than 4m. the size should be at least 50mm²
 - 3) Recommended battery capacity is over 200 amperes.
 - 4) Connect the battery (+) cable from the battery to the starter motor with the cable from alternator (+) cable.
 - 5) Connect the battery (-) cable and system ground connector to alternator housing or Engine block.
- * In case of a “Two Pole System”, connect battery (-) cable to the alternator housing.
- 6) Battery cables connectors should be clean and tightly fastened.

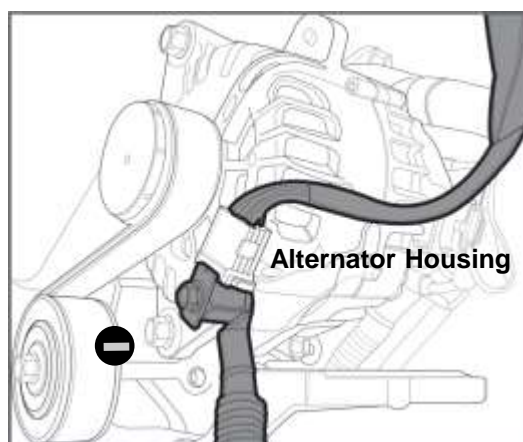
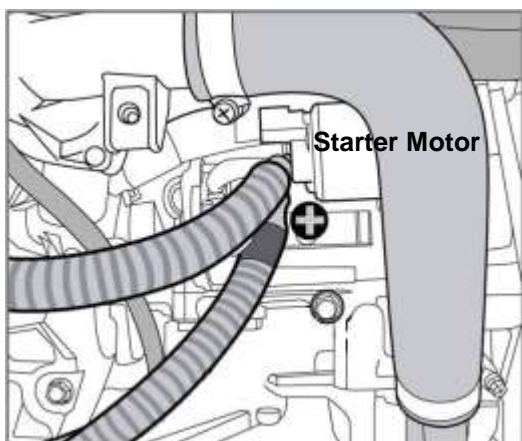

CAUTION

DO NOT TOUCH OR REMOVE ELECTRICAL PARTS WHEN STARTING OR DURING OPERATION.
KEEP HAND, HAIR, AND CLOTHES AWAY FROM THE FLYWHEEL AND OTHER ROTATING PARTS WHILE THE ENGINE IS RUNNING.

2. BATTERY CHECKS

Battery inspection is very important in electronic control engines: You must check the battery condition regularly.

LOAD TEST

- 1) Perform the following steps to complete the load test procedure for maintenance-free batteries.
- 2) Connect the load tester clamps to the terminals and proceed with the test as follows:
 - a. If the battery has been charged, remove the surface charge by connecting a 300 ampere load for 15 seconds.
 - b. Connect the voltmeter and apply the specified load.
 - c. Read the voltage after the load has been applied for 15 seconds.
 - d. Disconnect the load.
 - e. Compare the voltage reading with the minimum and replace the battery if battery test voltage is below that shown in the voltage table. If the voltage is greater than shown in the table, the battery is good. If the voltage is less than shown in the table, replace the battery.

Voltage	Temperature
9.6	20°C (70°F) and above
9.5	16°C (60°F)
9.4	10°C (50°F)
9.3	4°C (40°F)
9.1	-1°C (30°F)
8.9	-7°C (20°F)
8.7	-12°C (10°F)
8.5	-18°C (0°F)



WARNING

BATTERY MUST BE STORED AND WORKED ON IN A SAFE PLACE AWAY FROM CHILDREN AND SOURCES OF IGNITION. FLUID IN THE BATTERY IS A CORROSIVE ACID AND MUST BE HANDLED WITH CARE. IF SPILLED ON ANY PART OF BODY, FLUSH IMMEDIATELY WITH WATER.



CAUTION

DO NOT LOOSEN OR DETACH BATTERY TERMINALS WHILE ENGINE IS RUNNING. DOING SO WILL DAMAGE CHARGING SYSTEM AND OTHER ELECTRONIC DEVICES.

3. FUSE AND RELAY

3.1 FUSE

An engine's electrical system is protected from electrical overload damage by fuses.

If a fuse has blown, the element inside the fuse will be melted. If the electrical system does not work, first check the fuses in ECU box. Always replace a blown fuse with one of the same rating.



If the replacement fuse blows, this indicates an electrical problem. Avoid using the system involved and immediately consult an authorized Hyundai SeasAll dealer.

Fuses in the ECU Box

- 1) System Power: 30Amp
- 2) Ignition Power: 5Amp
- 3) ECM(ECU) Power: 20Amp
- 4) Main Relay Power: 15Amp
- 5) Spare: 30Amp
- 6) Fuel Filter: 30Amp



3.2 RELAYS

Relays in the ECU Box

- 1) Main Relay: 30 Amp
- 2) Oil Extraction Pump Relay: 30 Amp
- 3) Fuel Pump Relay : 30 Amp
- 4) Fuel Heater Relay: 30 Amp
- 5) Start Solenoid Relay: 30 Amp
- 6) Glow Relay: 70 Amp

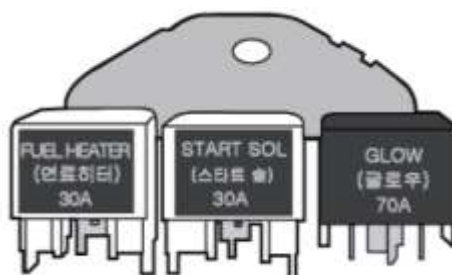
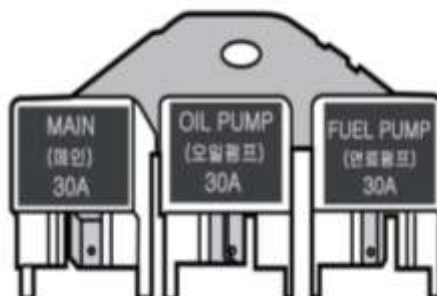

- Using an ohmmeter, check that there is continuity between each terminal.

Terminal	Continuity
30 - 87	NO
85 - 86	YES

- Check for continuity between terminals 30 and 87.
- Always replace a damaged relay with one of the same rating.

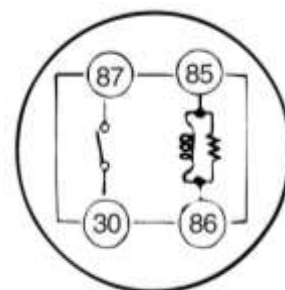
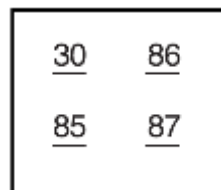

CHAPTER 8 INSTRUMENT SYSTEM

1. INSTRUMENT CONNECTIONS

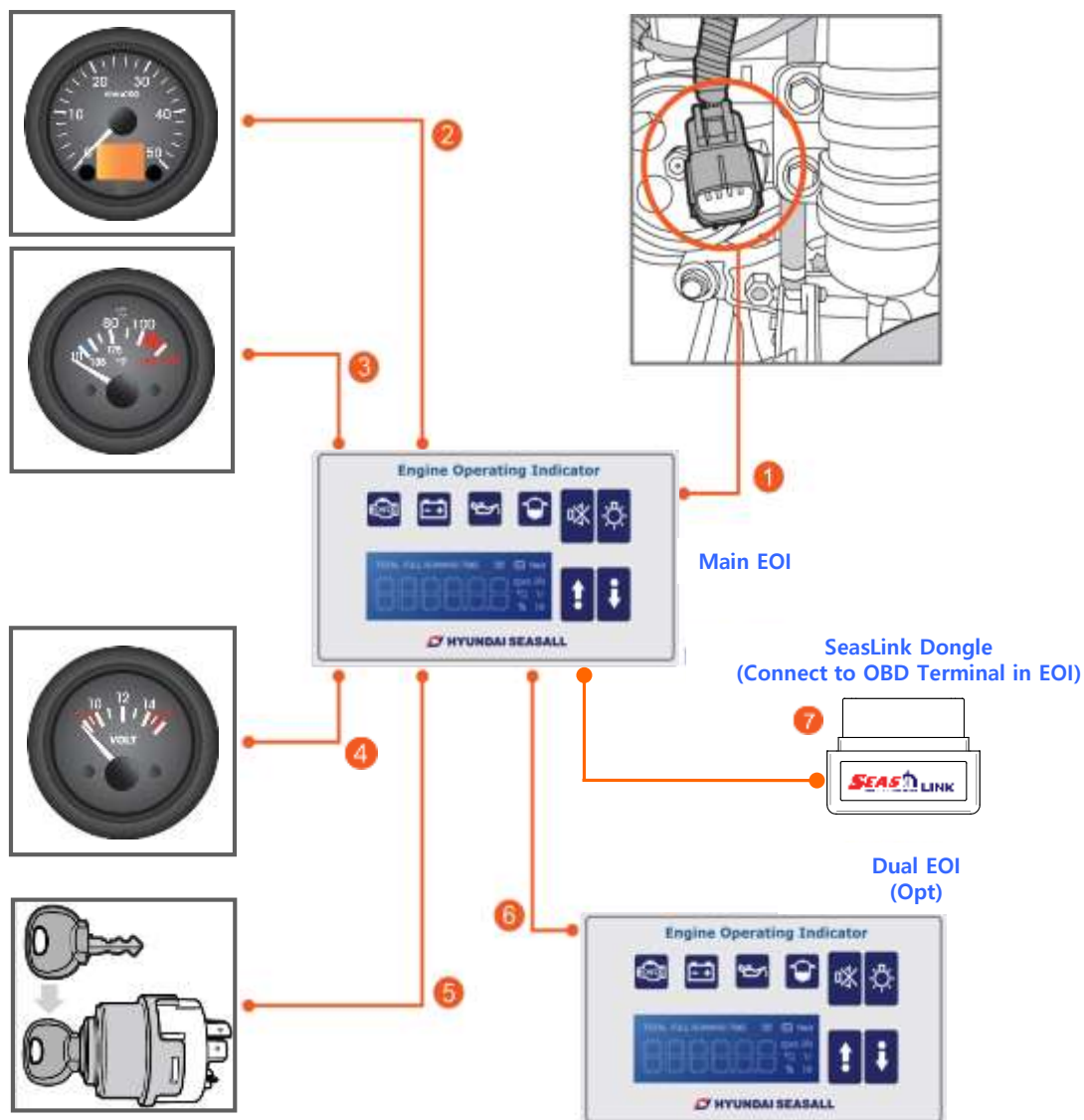

- ① Engine to EOI wiring (5m/7m/10m/15m) [00112-7D195, 00112-5S197, 00112-5S190, 00112-5S196]
 - ② EOI to RPM gauge (Ø 85) Wiring [00113-5S104, 00113-5S1G4(Chrome)]
 - ③ EOI to coolant temp gauge (Ø 52) Wring [00113-5S105, 00113-5S1G5(Chrome)]
 - ④ EOI to volt gauge(Ø 52) Wring [00113-5S106, 00113-5S1G6(Chrome)]
 - ⑤ EOI to Ignition key switch(Ø 57) Wring [00113-5S107]
 - ⑥ Dual EOI wiring (option for dual stage) [00112-5S199(5M), 00112-5S200(7M)]
 - ⑦ SeasLink Dongle (Connect to OBD Terminal in EOI) [00760-BS1G1]
- ※ For information about the installation and operation of the EOI (Engine Operating Indicator) system, please refer to Chapter 9.

1.1 STANDARD INSTRUMENTS

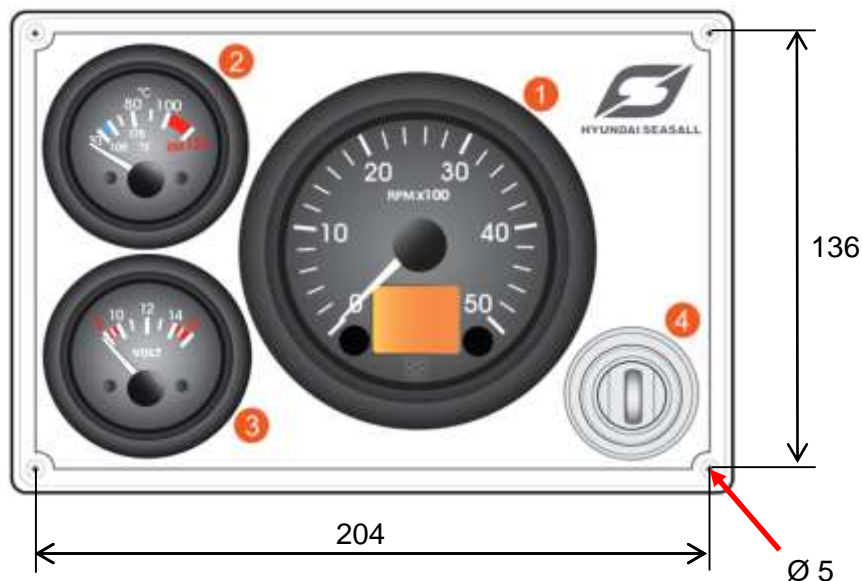

- ① RPM Gauge
- ② Coolant Temperature Gauge
- ③ Battery Voltmeter Gauge
- ④ Ignition Key switch

NOTE: Gauge panel (show above) is not standard but available as an option

1.2 COOLANT TEMPERATURE GAUGE

- This gauge will work when the key is in the 'ON' position.
- Avoid max. rpm and WOT (Wide Open Throttle) before a cold engine is fully warmed up as it can harm the engine.
- The gauge needle should be in proper range. If the outside temperature is high, the gauge needle may sit at a higher range. As long as the alarm doesn't sound, the engine is normal.
- If the gauge blinks and an EOI alarm sounds, check the coolant temperature and level. If the coolant is low, refill it.
- If the temperature of the engine coolant is higher than 105°C, the engine power will decrease. You should check the engine cooling system.



1.3 RPM GAUGE

- 1) When the key is at ignition ON position, this gauge will work.
- 2) This gauge indicates real-time engine rpm.
- 3) Avoid max. rpm and WOT (Wide Open Throttle) before a cold engine is fully warmed up, as it can harm the engine.

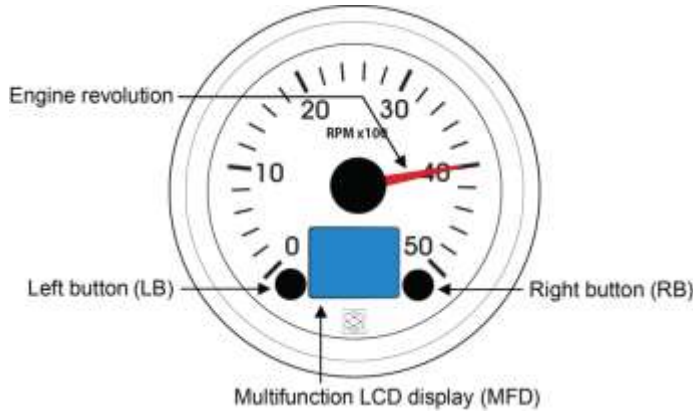

1.4 How to use RPM gauge and operation information indication (LCD)

- Pushing the Left or Right button will cycle through the information shown on the right. If a problem occurred, a warning lamp will turn on

<Warning Lamp>



Engine Check Symbol

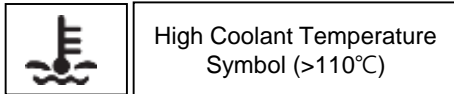

High Coolant Temperature Symbol (>110°C)

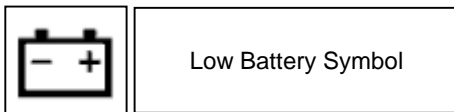

Low Battery Symbol

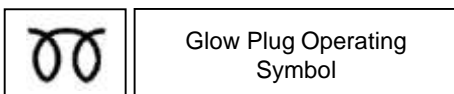

Glow Plug Operating Symbol

※ **Reset : Press left and right buttons at the same time for 3 seconds.**

Throttle % 65	● Throttle Lever Position : 65%
Cons l/h 12.5	● Fuel Consumption : 12.5 l/h
Cool °C 94	● Coolant Temperature : 94 °C
Battery v 13.8	● Battery Voltage : 13.8V
Dimmer Control <div style="width: 50%; height: 10px; background: linear-gradient(to right, lightblue, white);"></div>	● LCD Display Brightness Control Press left or right button for 3 seconds.
Hour h 30 253	● Running Time after reset : 30 Hr ● Total Accumulated Running Time : 253 Hr



1.5 BATTERY VOLT METER GAUGE

- This gauge will work when the key is in the "ON" position.
- This gauge indicates real-time battery voltage.
- If battery voltage is not sufficient, the engine can not be started.
- For a working engine, 12~16V volts is normal. If the battery voltage is under 12V, you should check battery and alternator.
- At the moment of engine ignition, the voltmeter needle may momentarily drop to 8V. This is normal.



2. CUT-OUT FOR GAUGE

- RPM Gauge : Ø 86 mm
- Coolant Temperature Gauge : Ø 53 mm
- Battery Volt Meter Gauge : Ø 53 mm
- Ignition Key : Ø 57 mm

3. CUT-OUT FOR EOI SYSTEM

- Use the enclosed template for EOI installation..

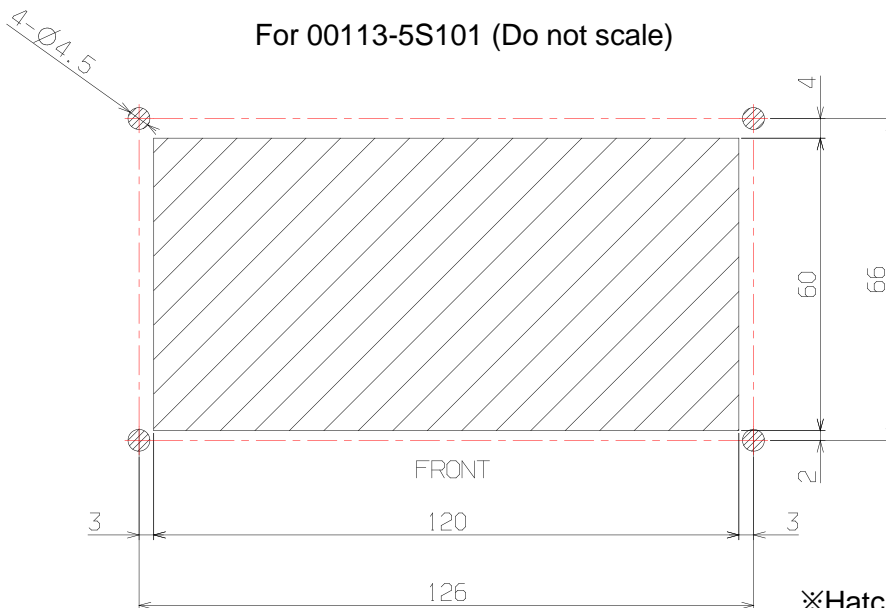

※Hatching : Cutting area

For 00113-5S101 + back cover (Do not scale)

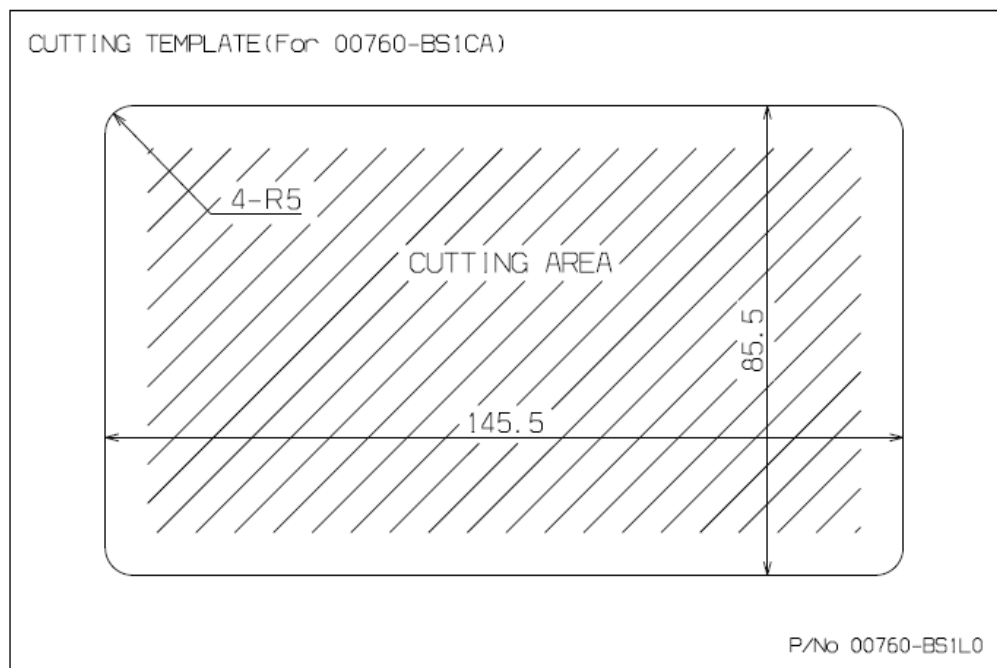

For NEW EOI 00760-BS1D0 (Do not scale)

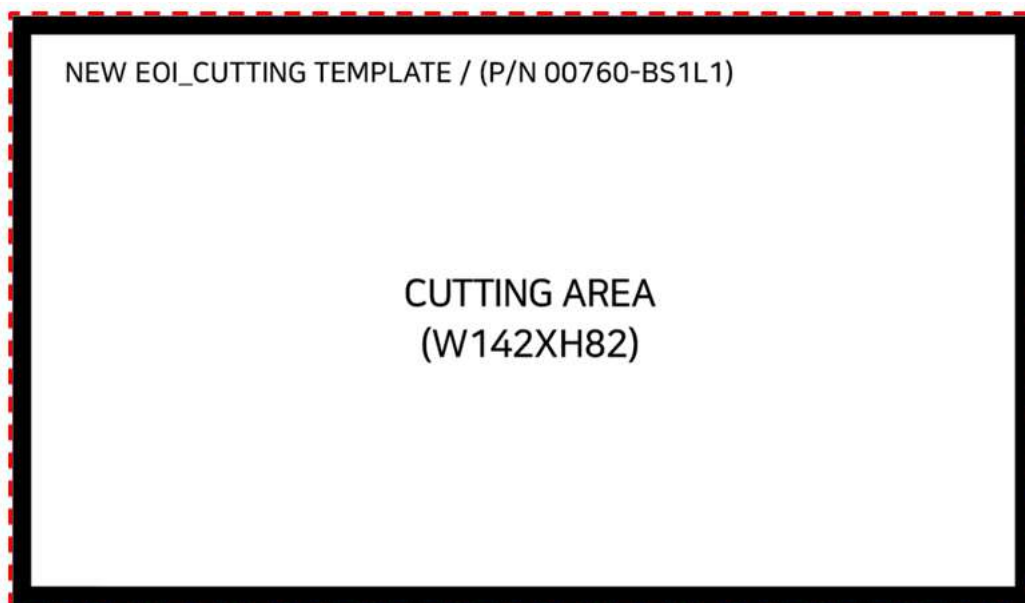

--- Cutting line

4. SEASLINK PRODUCT COMPONENTS

1) SeasLINK Dongle



Bluetooth 4.0
communication



2) Smart phone application
"SeasLINK"



- Engine Information
- Ship's Log
- Diagnosis
- Transmit Fault Data
- Group boating

WIFI or Mobile Network



3) Web site

" seaslink.hyundai-seasall.com"



5. INSTALLATION OF SEASLINK DONGLE

Install the SeasLINK dongle for communication between the engine and your smart phone. The dongle should be installed on the diagnosis connector (OBD Terminal) of the EOI. If you use the diagnosis tool, PLEASE REMOVE SEASLINK DONGLE.



SeasLINK Dongle

S2/S/D/U/R Engine

H/L Engine

5.1 DOWNLOAD APPLICATION

- 1) Android (Search word at Play Store : **seaslink**)
 - At least android OS version Kitkat (4.4.2)
 - Check : Settings → About phone → Software information

- 2) iPhone (Search word at App Store : **seaslink**)
 - At least iPhone 4S

5.2 CREATE AN ACCOUNT

1. Access on web page
 - Visit our website on your PC or smart phone
 "seaslink.hyundai-seasall.com"



2. Create ID/PW
 - Click 'Create an account' icon and create your account. ID and PW will be used for the application.



3. SeasLINK login
 - Input ID and PW on your smart phone application.









CHAPTER 9 EOI SYSTEM

The Engine Operating Indicator (EOI) system gives you a lot of information about the engine's current status. You can hear alarm beeps, or see information including RPM, coolant temperature, warning lamps, error codes and engine working time. If the switch is on, warning lamps for battery, engine oil and so on will flash. When the engine starts normally, the lamps all go off. If there is a problem, the specific lamp will come on. You should contact your nearest Hyundai SeasAll dealer and have the engine checked as soon as possible.

1. OVERVIEW OF EOI SYSTEM



	Engine Check Lamp
	Low Battery Lamp
	Low Oil Pressure Lamp (pressure < 0.5bar)
	Water Sensor Lamp (Water in Fuel)
	Alarm reset button
	LCD Display Brightness Control button
	Function button (operation information LCD)

1.1 INFORMATION LCD ITEM



1680 rpm	● Engine RPM : 1680 RPM	1.5 Hr	● Running Time after Key-on : 1.5 Hr
93.8 °C	● Coolant temperature : 93.8 °C	26 Hr	● Total WOT Accumulated Running Time : 26 Hr
70 %	● Throttle Lever position : 70%	P0087	● Diagnostic Trouble Code : P0087
15.7 l/h	● Fuel Consumption : 15.7 l/h	ⓘ Neut	● Warning Lever on Neutral
13.8 V	● Battery Voltage : 13.8V		

1.2 SWITCHES

- Buzzer Reset Switch - This switch is used for turning off the alarm temporarily.
- Dimmer Switch - This switch is used for controlling brightness of the other gauges connected to the EOI.
- Function Switch - This switch is used for changing the information display on the LCD.

1.3 ALARM LAMPS

Alarm may sound when alarm lamps flicker.

CHECK ENGINE LAMP



- This lamp informs you that the engine has a serious problem.
- You can see the DTC on the LCD of the EOI.
- It may be possible to drive at limited rpm. The ECU will control the functions to protect the engine. You should immediately have the engine checked at the nearest service shop.

ENGINE OIL LAMP



- This lamp informs you of the engine oil pressure low.
- If this lamp is on, you should stop the engine and check the oil level with oil gauge. If the oil is low, refill it. If you refill the oil and the lamp still does not turn off, you should ask your local service shop for maintenance.

ALTERNATOR LAMP



- This lamp informs you to recharge your battery.
- If this lamp is turned on, you should stop the engine and eliminate electric load, as well as check the alternator, alternator drive belt and wiring system.

WATER SENSOR LAMP



- This lamp informs you to extract water from fuel filter.
- If the lamp is on, you should stop the engine immediately and drain the water in the fuel filter.
- It is recommended to check and drain the water in the fuel filter at regular periods before the lamp turns on.
- It can be harmful to drive your engine with this lamp on.

2. EOI CONNECTIONS

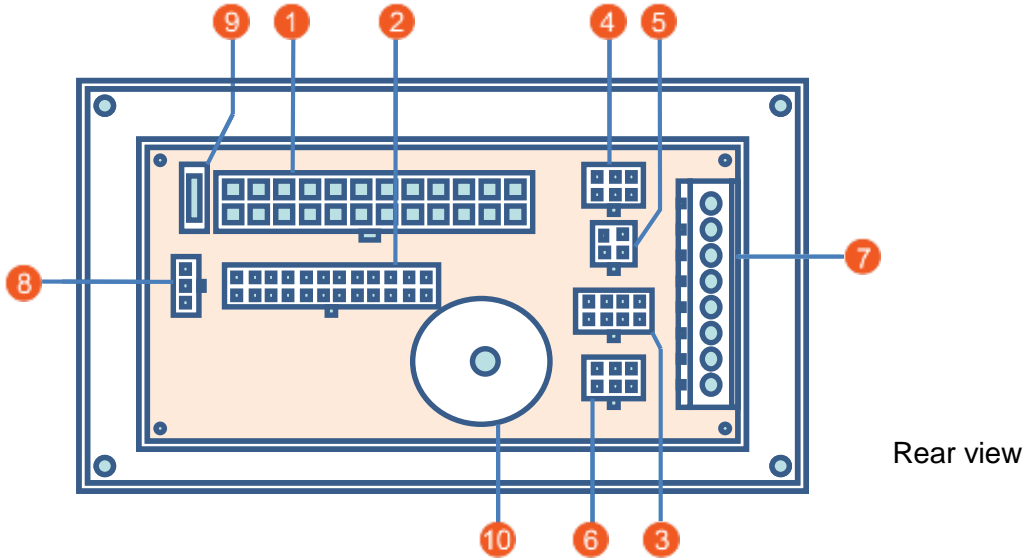

- | | |
|--|---|
| 1. Connection plug – CN1 (from engine) | 6. Connection plug – CN6 (service tool) |
| 2. Connection plug – CN2 (to dual EOI) | 7. Connection plug – CN7 (external) |
| 3. Connection plug – CN3 (tachometer) | 8. Connection plug – CN8 (key box) |
| 4. Connection plug – CN4 (coolant temp. gauge) | 9. System power fuse (3 amp) |
| 5. Connection plug – CN5 (volt gauge) | 10. Buzzer |

※ It can be connected to the CN6 of EOI box as well as G-scan connector in the ECU box.



WARNING

LISTEN FOR A CLICK WHEN FASTENING CONNECTORS. THIS SOUND INDICATES THAT THEY ARE SECURELY LOCKED



CAUTION

DON'T CONNECT EXTRA INSTRUMENTS WHICH DRAW MORE THAN 1 AMPERE. THE E.O.I WILL BE OVERLOADED AND DAMAGED

3. EOI PIN ASSIGNMENT

CN1 (MAIN EOI CONNECTOR FROM ENGINE)

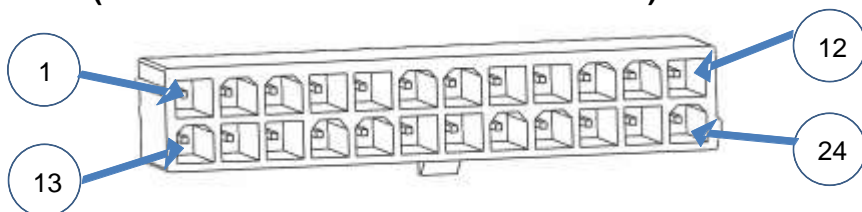

- | | |
|-------------------------------|---------------------|
| 1. Ignition power | 13. RPM signal |
| 2. Main relay power | 14. Spare |
| 3. Permanent power | 15. Spare |
| 4. Not used | 16. Spare |
| 5. Not used | 17. Neutral signal |
| 6. Coolant temperature signal | 18. K line |
| 7. Not used | 19. CAN_L |
| 8. Check lamp | 20. Changing signal |
| 9. Oil pressure signal | 21. CAN_H |
| 10. Ground | 22. Not used |
| 11. Not used | 23. Ground |
| 12. Water detection signal | 24. Not used |

CN2 (DUAL EOI CONNECTOR)

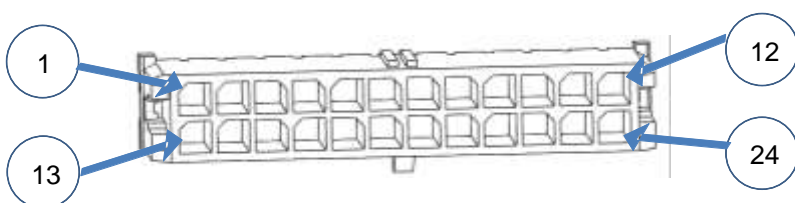

- | | |
|----------------------------|---------------------|
| 1. Ignition power | 13. RPM signal |
| 2. Main relay power | 14. Spare |
| 3. Permanent power | 15. Spare |
| 4. Not used | 16. Spare |
| 5. Not used | 17. Neutral signal |
| 6. Not used | 18. K line |
| 7. Not used | 19. CAN_L |
| 8. Check lamp | 20. Changing signal |
| 9. Oil pressure signal | 21. CAN_H |
| 10. Ground | 22. Not used |
| 11. Not used | 23. Ground |
| 12. Water detection signal | 24. Not used |



CN3 (TACHOMETER)

1. Main relay power
2. RPM signal
3. Ground
4. Illumination
5. Illumination
6. CAN_H
7. CAN_L
8. Not used



CN4 (COOLANT TEMP. GAUGE)

1. Coolant temperature signal
2. Ignition power
3. Ground
4. Illumination
5. Illumination
6. Not used

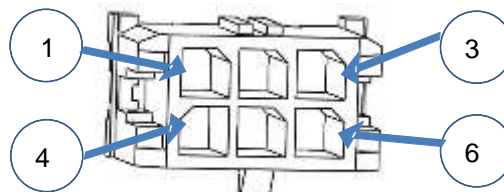

CN5 (VOLTMETER)

1. Ignition power
2. Ground
3. Illumination
4. Illumination

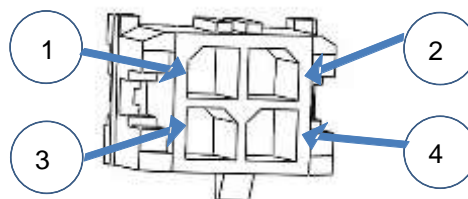

CN6 (SERVICE TOOL)

1. CAN_H
2. CAN_L
3. K_line
4. Ground
5. Main relay power
6. Not used

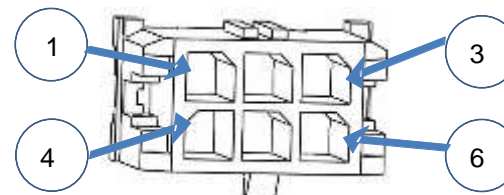

CN7 (EXTERNAL)

1. Ground
2. Permanent power
3. Ignition power
4. Neutral switch
5. Neutral switch
6. Charging signal
7. RPM signal
8. Dimmer

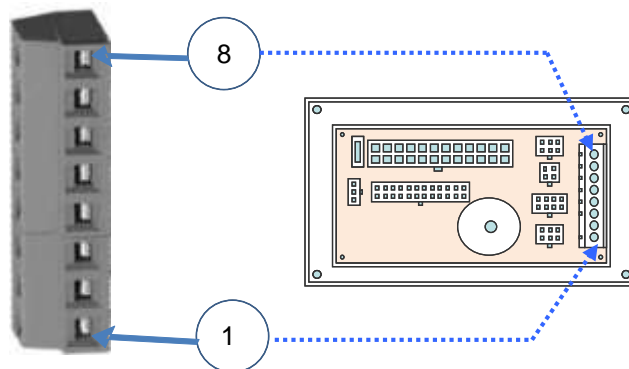

CN8 (KEY BOX)

1. Ignition power
2. Start power
3. Permanent power

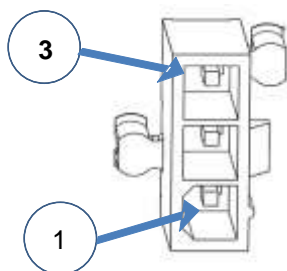

4. NEUTRAL SWITCH AND DUAL EOI CONNECTION

1) Neutral switch wires should be connected at pin #4 and #5 of the external connector of the EOI. If there is no neutral switch, jumper #4 and #5 with short wiring.

SYSTEM WITH A NEUTRAL SWITCH

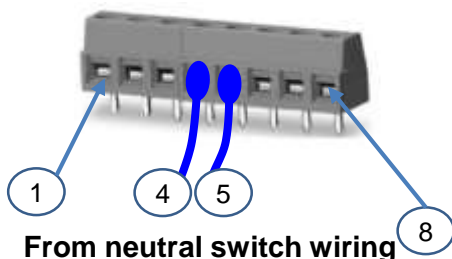

SYSTEM WITH NO NEUTRAL SWITCH

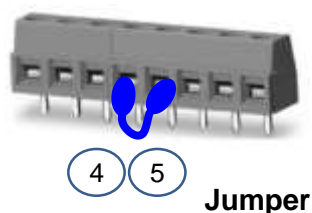

2) If there is a dual EOI, you should connect the wiring between #5 (external connector of the main EOI) and #5 (external connector of the dual EOI)

Main EOI external connector

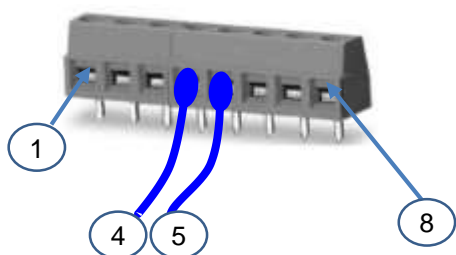

From neutral switch wiring

Dual EOI external connector

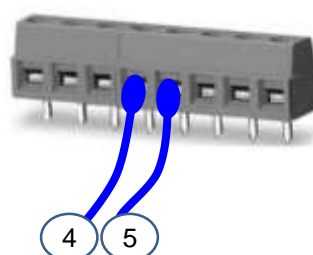

CAUTION

FOR USER'S SAFETY, ENGINE WILL NOT CRANK OR START IF GEAR POSITION LEVER IS NOT IN NEUTRAL OR NOT CONNECTED TO THE EOI EXTERNAL CONNECTION.

5. TRIM WIRING CONNECTION DIAGRAM

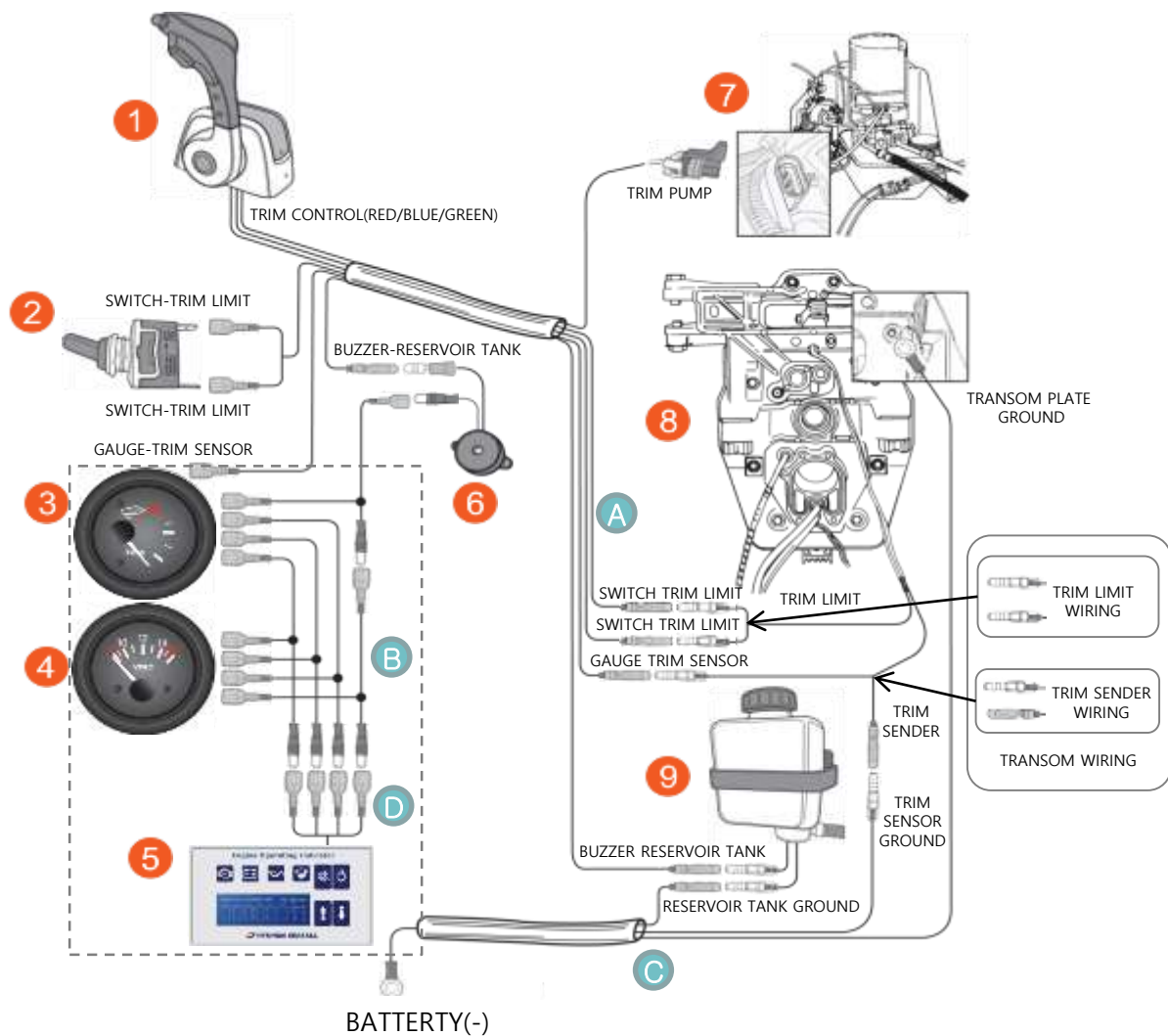

- | | | | |
|---|----------------------------------|---|---|
| ① | REMOTE CONTROL | ⑧ | TRANSOM PLATE |
| ② | TRAILER SWITCH | ⑨ | GEAR LUBE MONITOR |
| ③ | GAUGE-TRIM | A | WIRING-REMOTE CONTROL : 00112-2H122/5 |
| ④ | GAUGE-VOLT | B | WIRING-GAUGE & LAMP : 00112-2H123 (5EA) |
| ⑤ | EOI | C | WIRING-BATTERY GROUND : 00122-2H121 |
| ⑥ | BUZZER (DRIVE OIL) : 00113-1A152 | D | WIRING-BATTERY-VOLT : 00112-5S114 |
| ⑦ | TRIM PUMP | | |

* SWITCH of the SeaStar's controller models **CH1752P**, **CH7552P**, **CH7842P** are included within its package.

②

Trailer Switch not included. (Switch-Trim Limit A/B terminal must be modified)

5.1 GAUGE & LAMP WIRING CONNECTION DIAGRAM

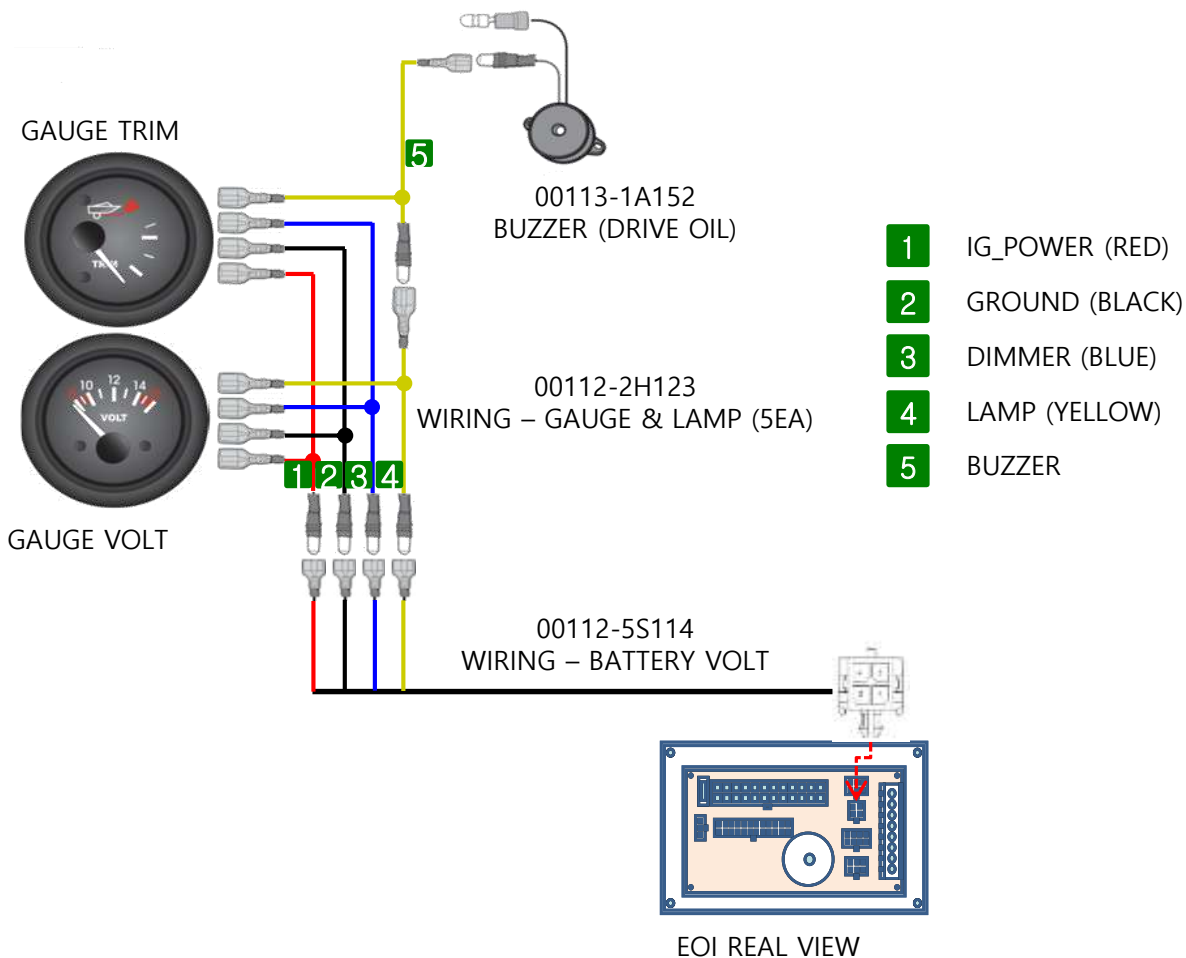

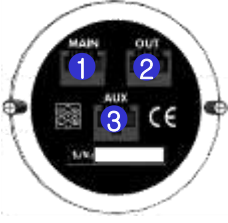
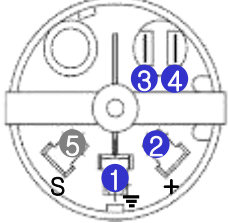
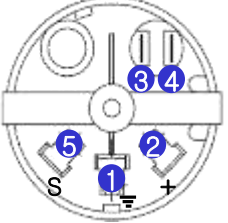
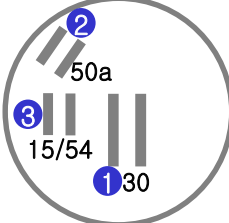
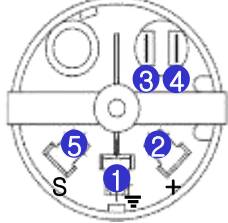
RPM	Battery Voltmeter	Coolant Temp.	Key Switch	Trim (Stern drive)
				
① MAIN ② OUT ③ AUX	① GND ② IG_POWER ③ DIMMER ④ LAMP ⑤ SIGNAL	① GND ② IG_POWER ③ DIMMER ④ LAMP ⑤ SIGNAL	① BATTERY(+) ② START ③ IG_POWER	① GND ② IG_POWER ③ DIMMER ④ LAMP ⑤ SIGNAL



INSTALLATION & OPERATION MANUAL

S270 Series Engines

5.2 INSTRUMENT SYSTEM (Back cover type EOI)

INSTRUMENT CONNECTIONS

SeasLink Dongle
(Connect to OBD Terminal in EOI)

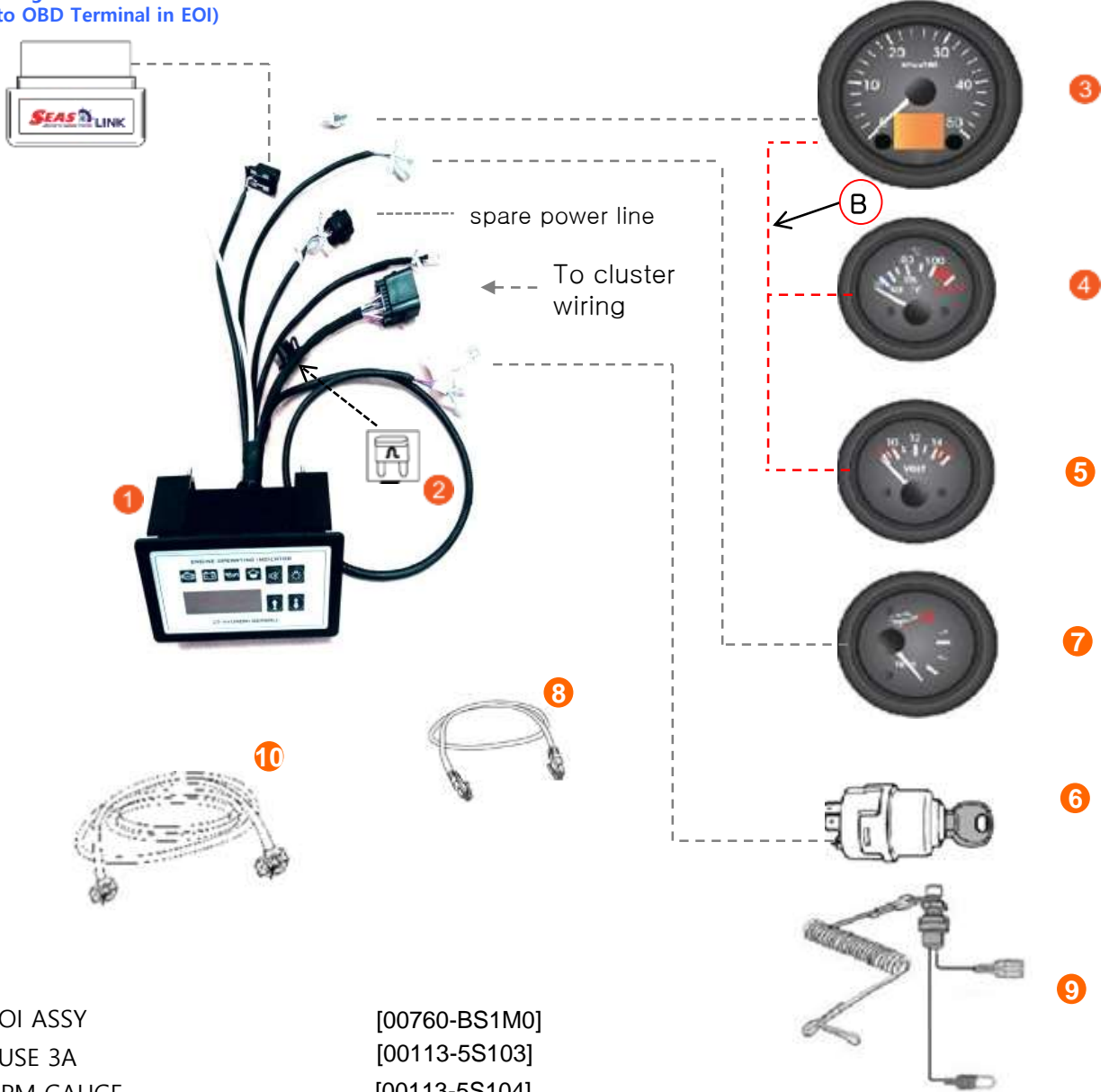

- | | | |
|----|----------------------------|---------------|
| 1 | EOI ASSY | [00760-BS1M0] |
| 2 | FUSE 3A | [00113-5S103] |
| 3 | RPM GAUGE | [00113-5S104] |
| 4 | COOLANT TEM.GAUGE | [00760-5S1G1] |
| 5 | BATTERY VOLT GAUGE | [00760-5S1G3] |
| 6 | KEY ASSY | [00113-5S107] |
| 7 | TRIM GAUGE | [00113-5S108] |
| 8 | WIRING HARNESS DIGITAL | [00760-5S1H1] |
| 9 | SAFETY STOP SWITCH | [00113-1A150] |
| 10 | WIRING HARNESS CLUSTER 10m | [00740-BS1H3] |
| | WIRING HARNESS CLUSTER 5m | [00740-BS1H4] |



5.3 TRIM WIRING CONNECTION DIAGRAM

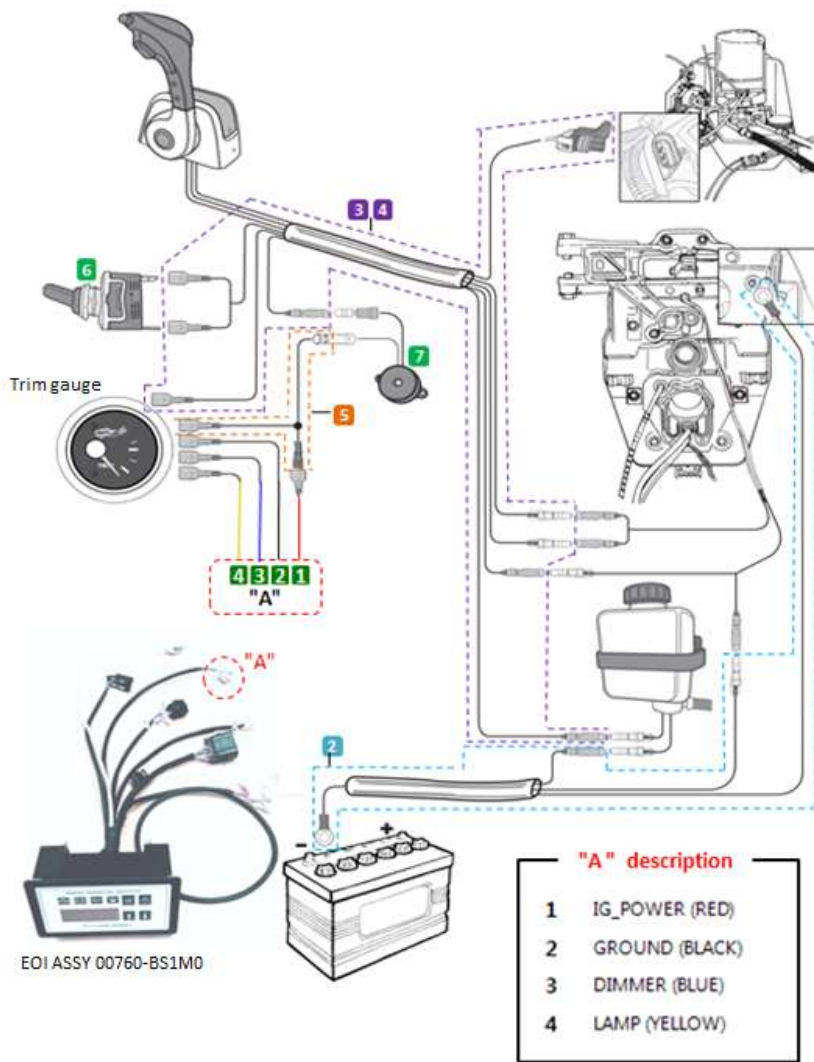

- | | | |
|----------|------------------------------------|--------------------------------------|
| 1 | TRIM WIRING ASSY (include 2,3,5,7) | 00112-2H100 |
| | TRIM WIRING ASSY (include 2,4,5,7) | 00112-2H200 |
| 2 | WIRING HARNESS BATTERY GND | 00112-2H121 |
| 3 | WIRING HARNESS-REMOTE CONTROL 10m | 00112-2H122 |
| 4 | WIRING HARNESS-REMOTE CONTROL 15m | 00112-2H125 |
| 5 | WIRING HARNESS TRIM GAUGE | 00112-2H123 |
| 6 | TRAILLER SWITCH | 00113-1A151 |
| 7 | BUZZER | 00113-1A152 (Single side mount only) |



INSTALLATION & OPERATION MANUAL

S270 Series Engines

HYUNDAI SEASALL

□ NEW EOI

Front



Rear



Power on Initial display red color box

Running Time		Engine Speed		Fuel Consumption		Load	
0 hr		0 RPM		0 /hr		0 %	
Total Running Time	BDT Time	Coolant Temp.	Battery Voltage	Oil Pressure	APS Position	Fuel Tank	Gear Box Oil P
0 hr	0 hr	0 °C	24 V	0 kPa	100 %	0 %	0 kPa

Power on	
Engine Speed	Fuel consum.
100 RPM	10 /hr
Coolant Temp.	Oil Pressure
25 °C	0 kPa
Battery Vol.	APS Position
24 V	100%

Electrical characteristic

No.	Parameter	Value
1	Display	3.5" TFT color LCD
2	Power supply	DC 10~34 V
3	Power consumption	<200 mA max.
4	Dimensions (W x H x D)	160 (W) x 100 (H) x 85 (D) mm
5	Water roof connector	4ea (MAIN, OBD, GAUGE, PTO function port)
6	Output data	1 external output buzzer (500mA max.)
7	Protection Grade	IPX6

** Include over current protect circuit in EOI set
Resettable Function, and prevent Over-current **by itself !**

Environmental specifications

Working temperature From	-20 to +70 °C
Storage temperature From	-30 to +70 °C

R,S2 Series EOI component list

Backcover ver.				NEW EOI		
No.	Name	Code	image	Code	image	Comment
1	EOI 아세이 SET_EOI ASSY	00760-BS1M0 00760-2R1M0 00760-1U1M0		00760-BS1D0		Mass prduction
2	키 아세이 Key Assy	00113-5S107		<-	<-	compatible
3	RPM 게이지 RPM-GAUGE	00113-5S104		<-	<-	compatible
4	크롬 RPM 게이지 CR RPM gauge	00760-5S1G4 [VSG12050/H1]		<-	<-	compatible
5	클러스터 하네스 Wiring Harness Cluster (10M)	00740-BS1H3		<-	<-	compatible with backcover type
6	클러스터 하네스 (연장) Wiring Harness Cluster (5 M extension)	00740-BS1H4		<-	<-	compatible with backcover type
7	APS_ASSY 악셀포지션 센서 아세이	00700-5S123(S) 00700-2R103 (R)		<-	<-	compatible
8	WIRING_APS_ADAPTOR 와이어링 아답터	00740-2S1H7		<-	<-	compatible
9	OBD 와이어링 OBD cable			00740-4H1HE		New (Ready)
10	게이지 와이어링 Gauge cable			00740-4H1HC		New (Ready)
11	EOI 와이어링 EOI to Cluster 400mm			00740-BS1HA		New
12	듀얼 EOI 와이어링 Dual EOI Extn wiring			00740-6L1HA		NEW
13	클러스터 와이어링 NEW EOI to CLUSTER (10m)	00740-BS1H7				Only OB30 & Dual EOI Sub Cluster wiring
14	클러스터 와이어링 (연장) NEW EOI EXTENSION (5m)	00740-BS1H8				Only OB30 & Dual EOI Sub Cluster wiring

- Old type "without backcover type Harness All & EOI exchange".

NEW EOI Engine wiring structure

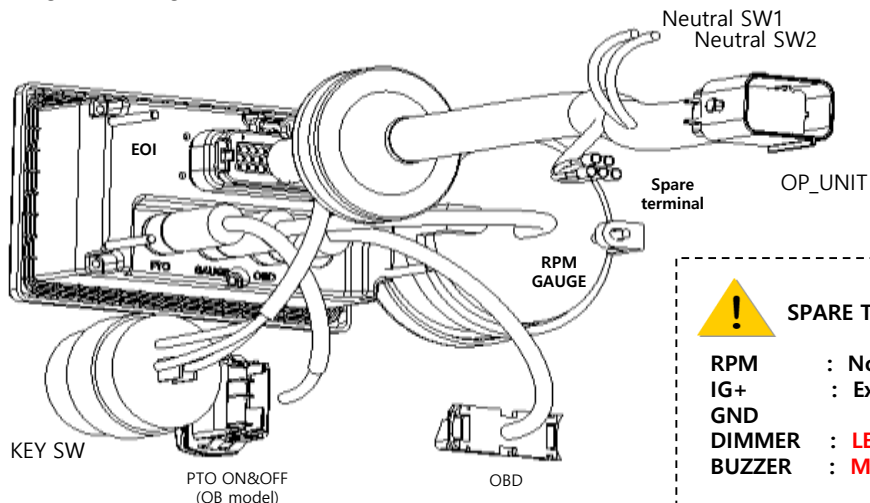

SPARE TERMINAL INFO.

- RPM : Not use
- IG+ : External gauge **max 3A**
- GND
- DIMMER : **LED type lamp control**
- BUZZER : **Max 500mA**

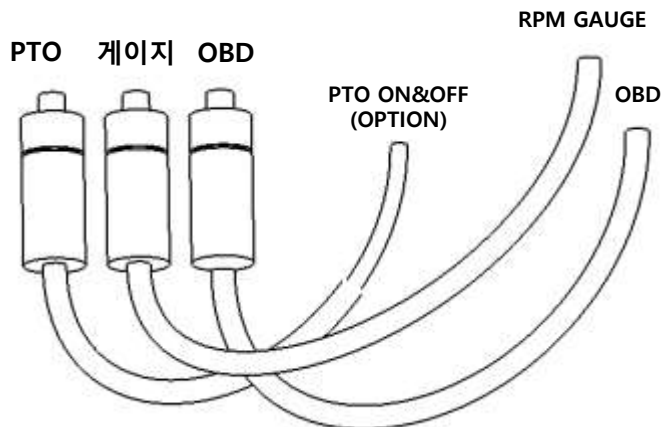

- PTO Cable : 00740-4H1HD (OB model PTO)
- GAUGE Cable : 00740-4H1HC
- OBD Cable : 00740-4H1HE

NEW EOI TRIM WIRING CONNECTION DIAGRAM

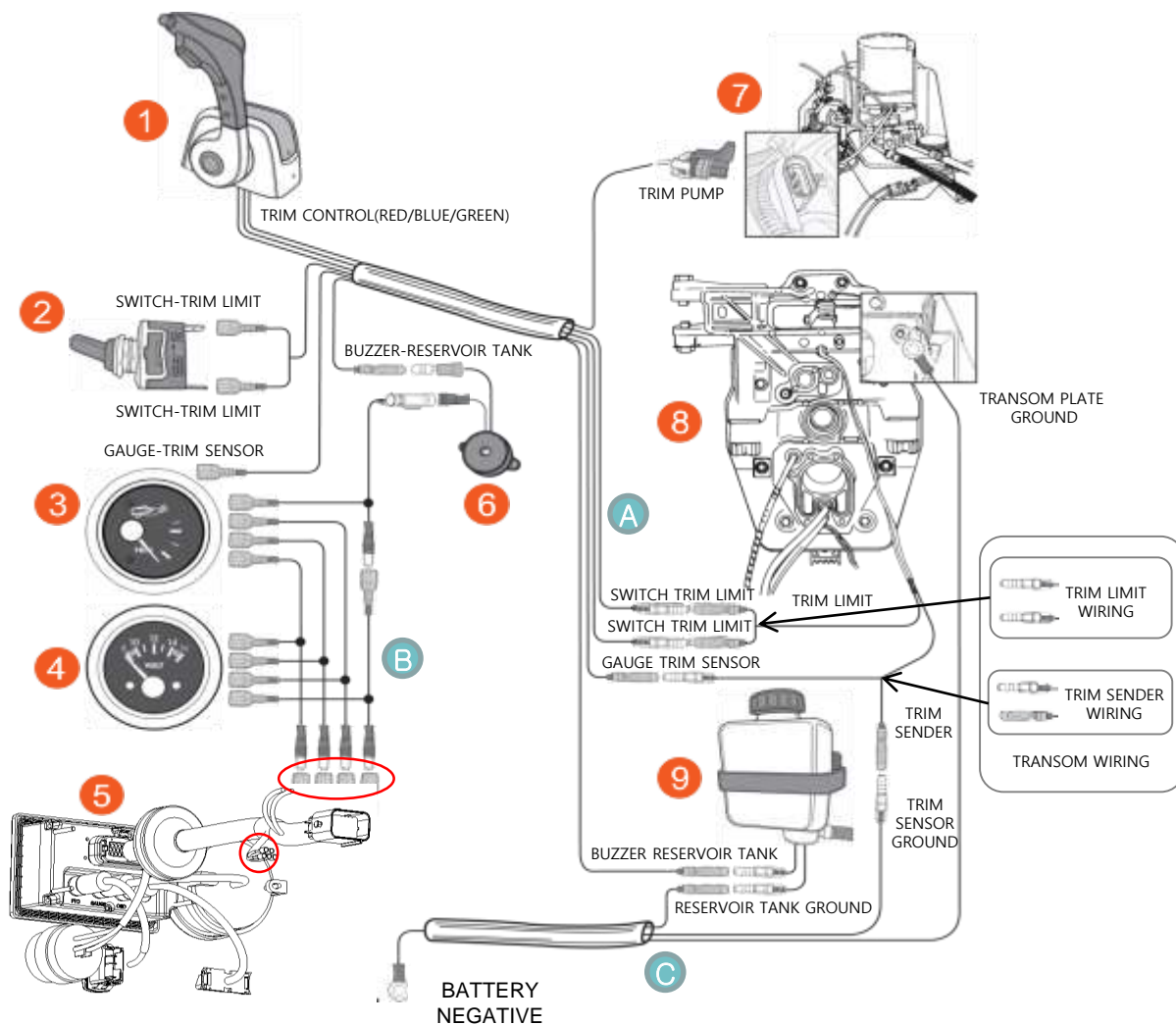

1	REMOTE CONTROL	8	TRANSOM PLATE
2	TRAILER SWITCH	9	GEAR LUBE MONITOR
3	GAUGE-TRIM	A	WIRING-REMOTE CONTROL : 00112-2H122/5
4	GAUGE-VOLT (option)	B	WIRING-GAUGE & LAMP : 00112-2H123
5	EOI	C	WIRING-BATTERY-VOLT : 00122-2H121
6	BUZZER (DRIVE OIL) : 00113-1A152		
7	TRIM PUMP		

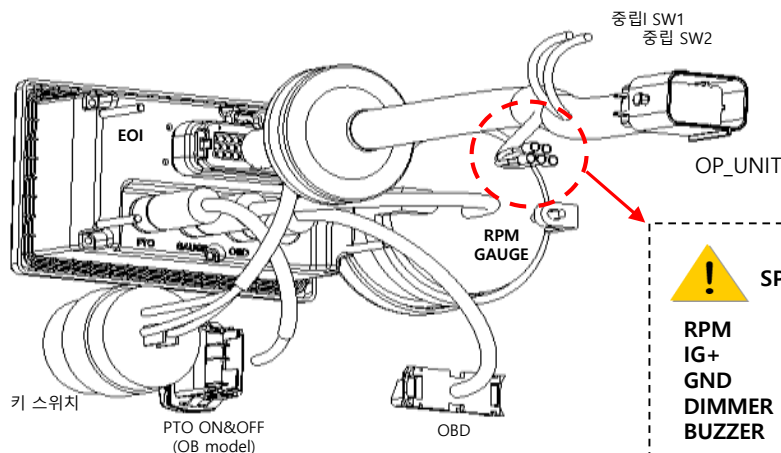

! SPARE TERMINAL INFO.

RPM : Not use
 IG+ : External gauge **max 3A**
 GND
 DIMMER : **LED type lamp control**
 BUZZER : **Max 500mA**

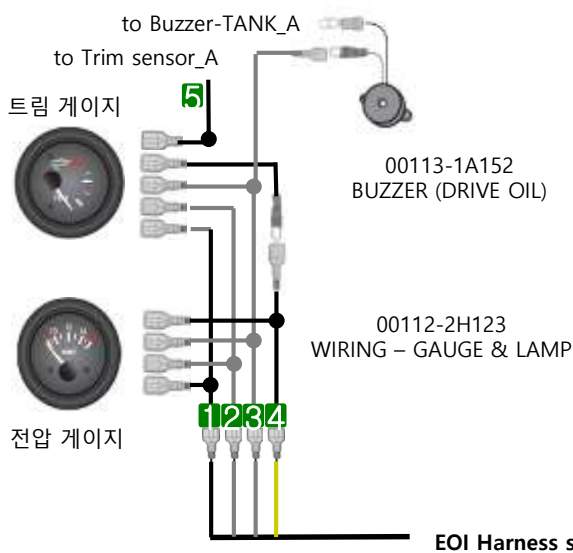

게이지 단자	스페어 단자	설명
1	GND	GND
2	IG+	IG+ 전원
3		
4	GND	GND
5		to Trim sensor_A

RPM	Battery Voltmeter	Coolant Temp.	Key Switch	Trim (Stern drive)
① MAIN ② OUT ③ AUX	① GND ② IG_POWER ③ DIMMER ④ GND	① GND ② IG_POWER ③ DIMMER ④ GND ⑤ SIGNAL	① BATTERY(+) ② START ③ IG_POWER	① GND ② IG_POWER ③ DIMMER ④ GND ⑤ SIGNAL

Dual EOI system

Main EOI

Sub EOI

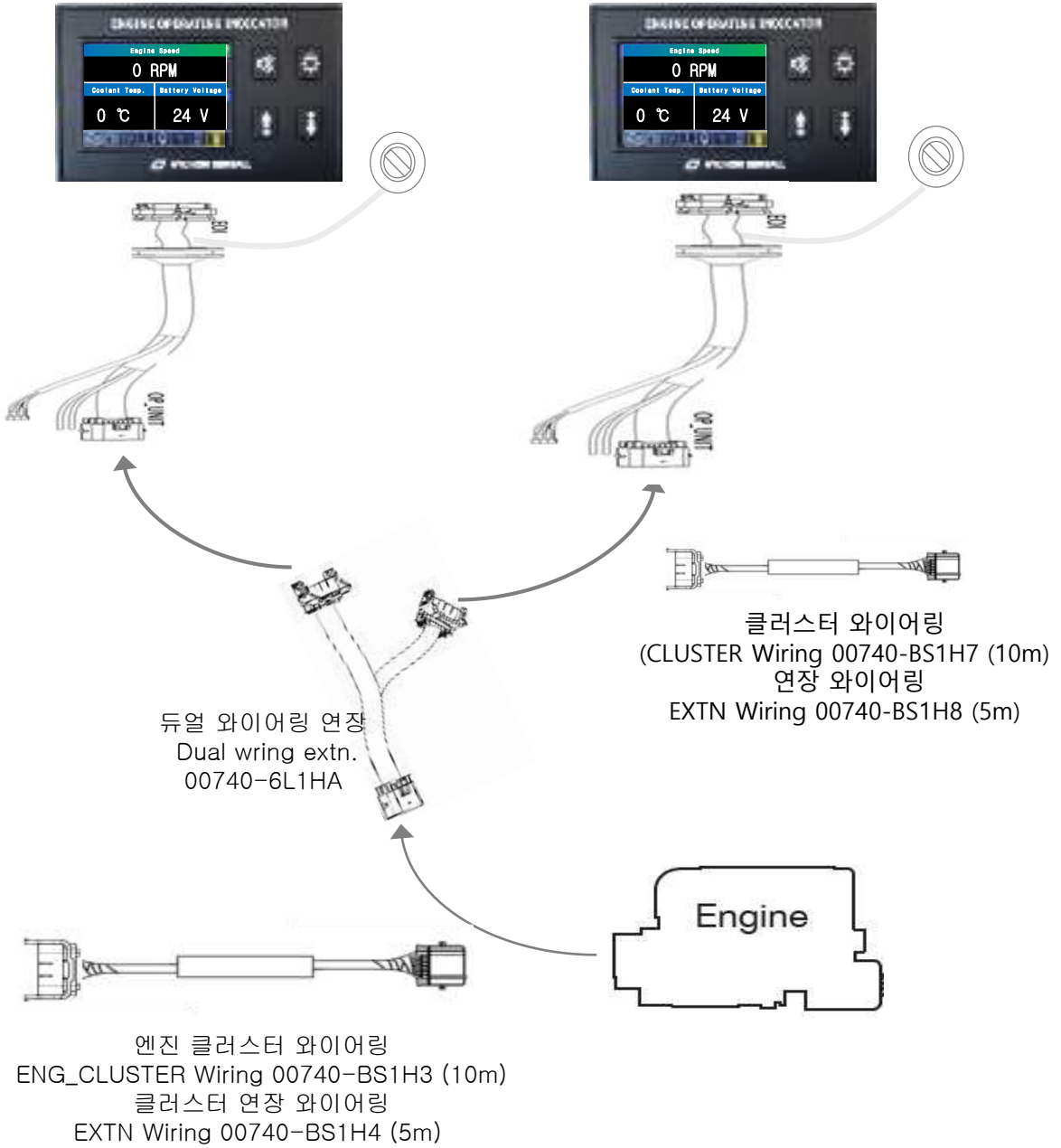



INSTALLATION & OPERATION MANUAL

S270 Series Engines

Dual EOI system EOI setting guide

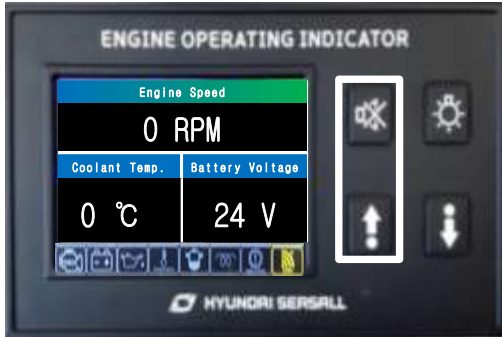

+ : 3s long button press

: Menu move

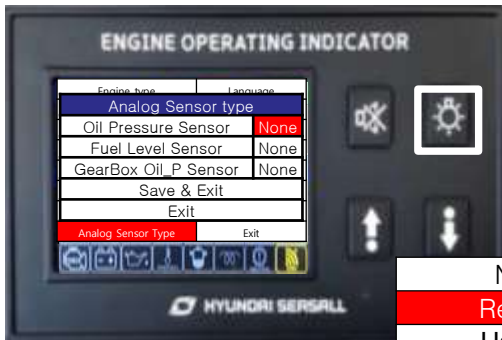

: Sensor type change "Remote"

None
Remote
User(V)
User(Ω)
0.5~4.5V
VDO_P28
VDO_P10

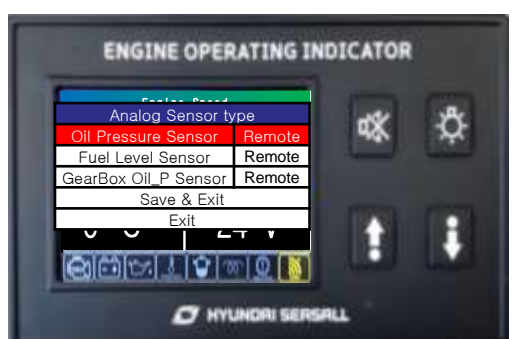
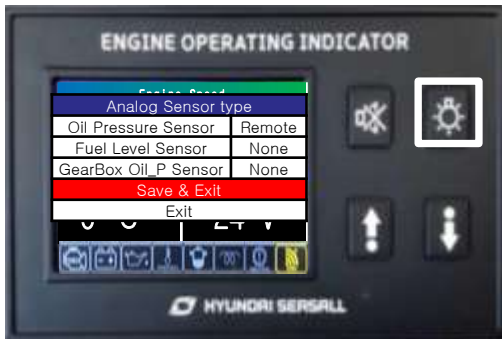

Save & Exit → recheck for Analog Sensor type "Menu"





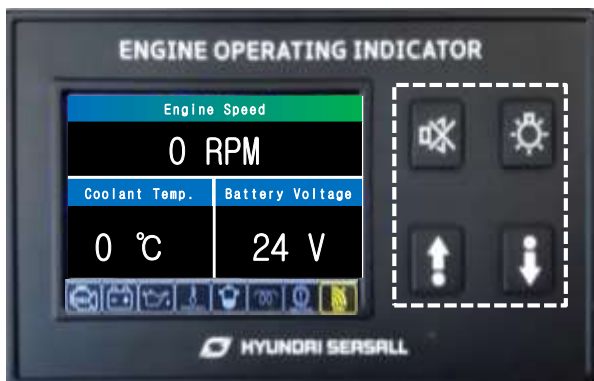



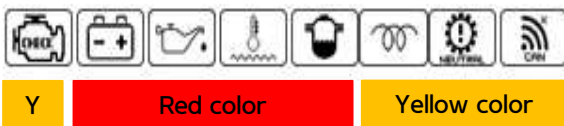



Fuel level, GearBox oil_P sensor is automatically changed.

EOI Button function



Symbol Lamp color



Short button press function	
	Mute -> Alarm sound "OFF"
	Page move (page up)
	Dimmer control 4 step / Menu select button
	Page move (Page down)
Long button press (Hot Key function)	
	5s long button -> button sound "ON or OFF"
	5s long button -> Language change "KOREAN or ENGLISH"
	5s long button -> Running Time initialization
	5s long button -> Serial No.
 + 	3s long button -> Setup menu
 + 	3s long button -> Time parameter show (rating time)



INSTALLATION & OPERATION MANUAL

S270 Series Engines

Engine monitoring parameter

PTO Mode
G,H,L Series

1 Engine Speed		3 PTO	
2 0 RPM			
Coolant Temp.		Battery Voltage	
0 °C		0 V	

Part	Description
1	Engine parameters name
2	Parameters data value
3	G, H, L Series PTO mode indicate

Layout TRIPLE : ECU and sensor data

Fuel Consumption	
0 l /hr	
Oil Pressure	APS Position
0 kPa	0 %

Layout TRIPLE: External Sensor data

Load	
0%	
Fuel Tank	Gear Box Oil_P
0 %	0 kPa

• Calculated value "Load"
 $\text{Fuel consumption} / \text{Max fuel consumption} * 100$

Layout SIX : Engine ECU parameter

Engine Speed	Fuel consum.
100 RPM	10 /hr
Coolant Temp.	Oil Pressure
25 °C	0 kPa
Battery Vol.	APS Position
24 V	100%

Layout TRIPLE: Time parameter

Running Time	
0.0 hr	
Total Running Time	WOT Time
0.0 hr	0.0 hr

System setting

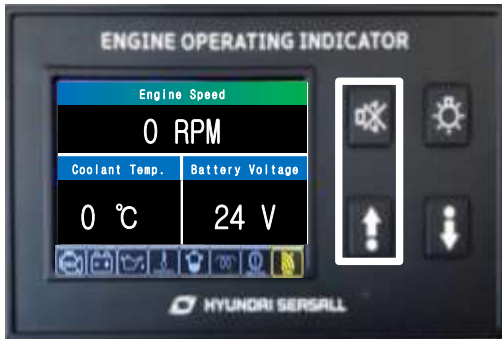

3s long button press



Button select

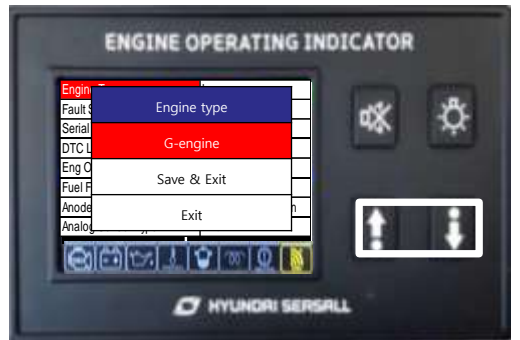
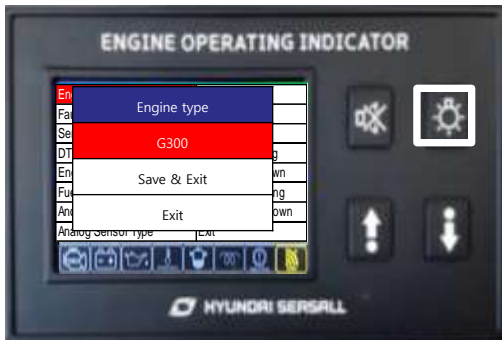

Press the Menu button and select engine series



Page move



Save & Exit select



Menu setup page Exit hotkey function "EXIT"

Menu description SYSTEM CONFIG

(When selecting the engine type, it is automatically selected.)

Engine type	Fault Shutdown	Serial No	DTC List	Oil&Filter Exchange	
G350	ON		P0001 (Past)	Period Time	250hr
Save & Exit	Save & Exit		P0001 (Currently)	Run Time	0.0hr
Exit	Exit		P0002 (Currently)	Clear Run Time	
				Save & Exit	
				Exit	



Menu select button -> value setting -> Save & Exit

Fuel filter Exchange		Anode Exchange		Analog Sensor type	
Period Time	600hr	Period Time	250hr	Oil Pressure Sensor	0.5~4.5
Run Time	0.0hr	Run Time	0.0hr	Fuel Level Sensor	32~240 Ω
Clear Run Time		Clear Run Time		GearBox Oil_P Sensor	VDO P28
Save & Exit		Save & Exit		Save & Exit	
Exit		Exit		Exit	

** Refer to chart "Service item cycle time"

Analog Sensor type	
Oil Pressure Sensor	None
Fuel Level Sensor	None
GearBox Oil_P Sensor	None
Save & Exit	
Exit	

None
Remote
User(V)
User(Ω)
0.5~4.5V
VDO_P28
VDO_P10

Analog Sensor type	
Oil Pressure Sensor	VDO P10
Fuel Level Sensor	Level 100
GearBox Oil_P Sensor	VDO P28
Save & Exit	
Exit	

** External sensor type user any vendors

Analog Sensor type	
Oil Pressure Sensor	VDO P10
Fuel Level Sensor	240~33 Ω
GearBox Oil_P Sensor	VDO P28
Save & Exit	
Exit	

None
Remote
User(V)
User(Ω)
0.5~4.5V
Level 300 Ω
Level 240~33 Ω
Level 100 Ω

** For example sensor image

fuel range empty "240 Ω" ~ Full "33 Ω" range



** Default level display range (Ω)
Empty "240" ~ Full "33" range

Language	Button Sound	Over Speed	Coolant Warning	Coolant Shutdown
English	On	2400 rpm	110 °C	120 °C
Save & Exit	Save & Exit	Save & Exit	Save & Exit	Save & Exit
Exit	Exit	Exit	Exit	Exit

 Hot key 5s push "English" mode

 Hot key 5s push "Sound OFF" mode

Oil Press Warning	Oil Press Shutdown	Exit
50 kPa	30 kPa	
Save & Exit	Save & Exit	
Exit	Exit	

Alarm management Fault display and alarm



Case 1
Safety Fault list (refer to chart next page)

1. Over speed
2. Water temperature
3. Oil pressure

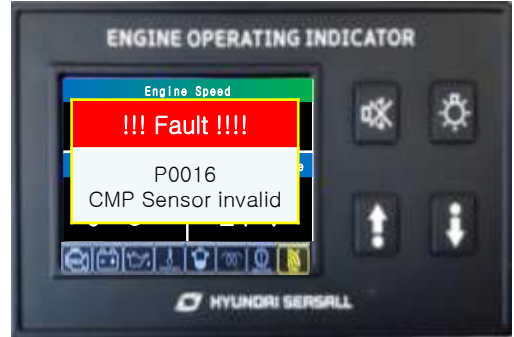

Case 2
Diagnostic Trouble Code pup-up (DTC P-CODE information)



Case3 Multi DTC
Diagnostic Trouble Code pup-up (DTC P-CODE information)

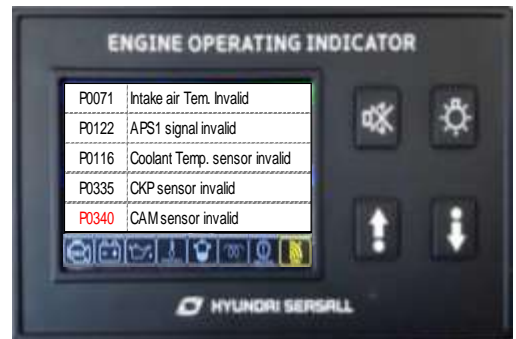

DTC list
Black color P-Code (Past Code)
Red color P-Code (currently DTC)



Case4 Service item alarm



Service item cycle time refer to chart (next page)

Chart 1 (Default setting value of Engine model)

No	Parameter		Engine type								
			R	S2	G300	G350	H380	H410	L500	L600	L700
1	Fault shutdown		On	<-	<-	<-	<-	<-	<-	<-	<-
2	Serial No.										
3	DTC List										
4	ENG Oil&Filter Exchange		<-	<-	250	<-	<-	<-	<-	<-	<-
5	Fuel Filter Exchange		<-	<-	600	<-	<-	<-	<-	<-	<-
6	Anode Exchange		<-	<-	250	<-	<-	<-	<-	<-	<-
7	Analog Sensor type	Oil pressure	None	<-	<-	<-	VDO P10	<-	<-	<-	<-
8		Fuel level	None	<-	<-	<-	<-	<-	<-	<-	<-
9		Gear box pressure	None	<-	<-	<-	<-	<-	<-	<-	<-
10	Language		Korean	<-	<-	<-	<-	<-	<-	<-	<-
11	Unit		Mertic	<-	<-	<-	<-	<-	<-	<-	<-
12	Over speed		4560	<-	3000	3360	2160	2400	2160	2400	2760
13	Coolant warning.		110℃	<-	<-	<-	<-	<-	<-	<-	<-
14	Coolant shutdown		120℃	<-	<-	<-	<-	<-	<-	<-	<-
15	Oil pressure warning		30 kPa	30 kPa	50 kPa	<-	<-	<-	<-	<-	<-
16	Oil pressure shutdown		30 kPa	30 kPa	30 kPa	<-	<-	<-	<-	<-	<-

User optional (Fuel level, Gear box pressure sensor type of any vendor)

** ex) fuel level sensor guide line

예) Gear box pressure sensor

empty “240 Ω” ~ full “33 Ω” type

Field customizing of any vendor



Hot key button function

 5s long button press



Button Sound on/off

 5s long button press

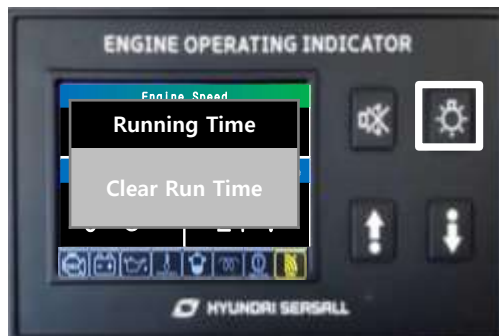

Running Time Clear

 5s long button press





Language support "English or Korean"

 5s long button press



EOI Serial No. check

 +  3s long button press

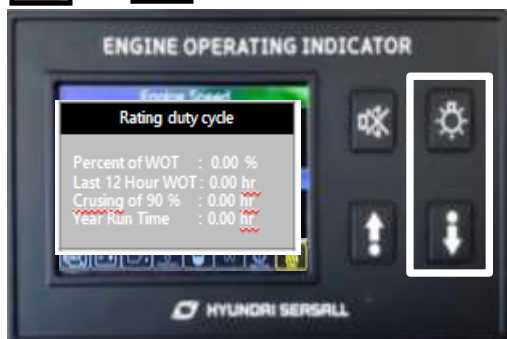

Rating duty cycle time check



6. G-SCAN

The G-SCAN is a diagnostic tool which dealers can use for DTC analysis, fault code searches, data analysis and ECU upgrades.



6-1. G-SCAN CONNECTIONS

G-scan can be connected to the CN6 connector of EOI, as well as G-scan connector in the ECU box. For information about the CN6 of EOI, please refer to Chapter 9.

※ When the G-SCAN is connected, the EOI cannot be used to communicate with the engine. When using the G-Scan, the SeasLINK dongle must be unplugged.

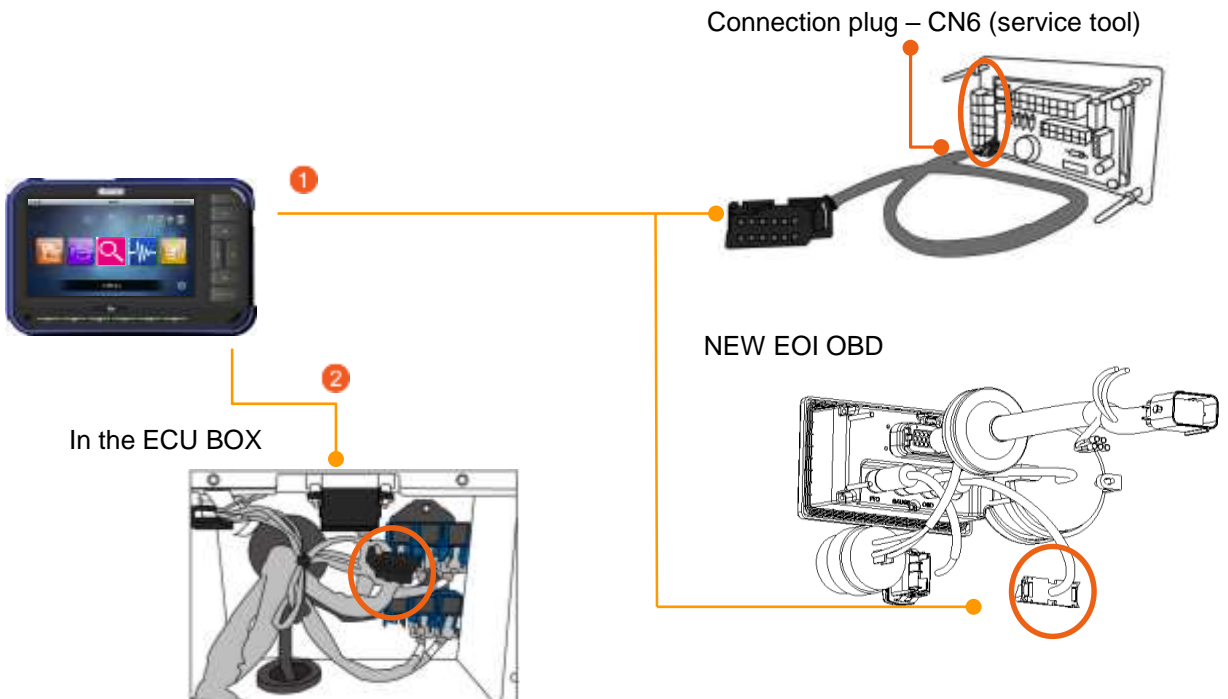



INSTALLATION & OPERATION MANUAL

S270 Series Engines

7. ALARM AND DTC (DIAGNOSIS TROUBLE CODE)

If there is a problem in the engine, the EOI display (audible or visible) alarm and related DTC (diagnosis trouble code) will give you information about it. The DTC display is only for initial assistance and to aid communication with a Hyundai SeasAll dealer if there is an emergency. You should contact your nearest Hyundai SeasAll dealer as soon as possible if a system problem arises.

Note 1) RPM Limit : ● (Rated rpm - 500rpm), ○ (Rated rpm - 800rpm)

Note 2),3) would be applied to S250/220 models

7.1 ALARM LIST

Item	DTC	Description	Fail safety		Alarm		Expectation Cause(s)
			Fuel cut off	Note 1) RPM limit	Lamp	Buzzer	
VGT variable geometry turbocharger	P2263 P2268 P226(5/6) P2267	GPA failure [PWM failed, Positioning failed, Operating range failed(UMS/LMS), Overheat]	-			√	• Overload, VGT cooling circuit • VGT actuator adaption error • VGT actuator performance error
	P2563	Pwm line Failure					
	P0048	Short circuit battery					
	P0047	Short circuit ground	-	○		√	• VGT actuator circuit • VGT actuator
		No Load					
	P0234	Boost pressure higher than target value					• VGT actuator performance error
P0299	Boost pressure lower than target value	-			√	• Air leakage check • Intercooler • VGT actuator performance error	
APS1 acceleration position sensor1	P2138	Plausibility With Aps2 Violated					
	P2127	Voltage Above Lower Limit					
	P2123	Voltage Above Upper Limit					
	P0643	Supply Voltage Above Upper Limit					
	P0642	Supply Voltage Below Lower Limit	-	1250 rpm fixed		√	• APS1/2 sensor circuit • APS sensor • ECM (engine control module)
APS2 acceleration position sensor2	P2128	Voltage above upper limit					
	P0653	Supply voltage above upper limit					
	P0652	Supply voltage below lower limit					
CMPS cam position sensor	P0340	No camshaft signal	√ (at starting)	●		√	• CMPS circuit • CMPS
	P0341	Wrong camshaft signal					
CKPS crank position sensor	P0335	No crankshaft signal (engine running)	√	-		√	• CKPS circuit • CKPS • Target wheel check
	P0336	Wrong crankshaft signal (restart)					
Water detection in fuel	P2264	Water in fuel is detected	-	●		√	• Water in fuel, fuel filter (drain out water and check the fuel in fuel tank) • Warning lamp circuit • Water detection sensor error
Cylinder1 injector	P0201	Open load		○			
	P0261	Short circuit ground					
	P0262	Short circuit battery	√			√	• Injector circuit • Injector
	P0263	Defect resistance cylinder1, Charging/discharging energy error	-				
Cylinder2 injector	P0202	Open load		○			
	P0264	Short circuit ground					
	P0265	Short circuit battery	√			√	• Injector circuit • Injector
	P0266	Defect resistance cylinder1, Charging/discharging energy error	-				



INSTALLATION & OPERATION MANUAL

S270 Series Engines

HYUNDAI SEASALL





Item	DTC	Description	Fail safety		Alarm		Possible Cause(s)		
			Fuel cut off	Note 1) RPM limit	Lamp	Buzzer			
Cylinder3 injector	P0203	Open load		○			<ul style="list-style-type: none"> • injector circuit • injector 		
	P0267	Short circuit ground	√			√			
	P0268	Short circuit battery							
	P0269	Defect resistance cylinder1, Charging/discharging energy error	-	-					
Cylinder4 injector	P0204	Open load		○			<ul style="list-style-type: none"> • injector circuit • injector 		
	P0270	Short circuit ground	√			√			
	P0271	Short circuit battery							
	P0272	Defect resistance cylinder1, Charging/discharging energy error	-	-					
Note 2) Cylinder5 injector	P0205	Open load		○			<ul style="list-style-type: none"> • injector circuit • injector 		
	P0273	Short circuit ground	√			√			
	P0274	Short circuit battery							
	P0275	Defect resistance cylinder1, Charging/discharging energy error	-	-					
Note 3) Cylinder6 injector	P0206	Open load		○			<ul style="list-style-type: none"> • injector circuit • injector 		
	P0276	Short circuit ground	√			√			
	P0277	Short circuit battery							
	P0278	Defect resistance cylinder1, Charging/discharging energy error	-	-					
Injector Bank Error	P062D	Bank 1 error	√	-		√	<ul style="list-style-type: none"> • Charging system (battery, alternator check) • ECM 		
	P062E	Bank 2 error							
Injectors Circuit	P0611	Error path for short circuit of charging switch is detected	√	-		√	<ul style="list-style-type: none"> • injectors circuit • ECM 		
	P0200	Injector circuit error							
RPS rail pressure sensor	P0193	Voltage above upper limit	-	●		√	<ul style="list-style-type: none"> • PRS circuit • PRS • APS 2 power supply circuit • BPS power supply circuit • ECM 		
	P0192	Voltage below lower limit							
	P0653	Supply voltage above upper limit							
	P0652	Supply voltage below lower limit							
Rail pressure Monitoring	P0087	Maximum positive deviation of rail pressure exceeded	-	○		√	<ul style="list-style-type: none"> • Fuel filter • RPS check • P-PRV , PRV check(stuck) 		
	P0088	Maximum negative deviation of rail pressure exceeded							
	P1171	Minimum rail pressure exceeded						√	-
	P1172	Maximum rail pressure exceeded						-	○
BPS boost pressure sensor	P0238	Voltage above upper limit	-	●		√	<ul style="list-style-type: none"> • BPS circuit • BPS • RPS power supply circuit • APS 2 power supply circuit • ECM 		
	P0237	Voltage below lower limit							
	P0069	Not plausible with atmospheric pressure sensor						-	-
	P0653	Supply voltage above upper limit						-	-
	P0652	Supply voltage below lower limit						●	



INSTALLATION & OPERATION MANUAL

S270 Series Engines

HYUNDAI SEASALL

Item	DTC	Description	Fail safety		Alarm		Possible Cause(s)		
			Fuel cut off	High 1) RPM limit	Lamp	Buzzer			
PPRV pump pressure regulator valve	P0254	Short circuit to battery of metering unit output	-	○		√	<ul style="list-style-type: none"> • P-PRV circuit • P-PRV 		
	P0253	Short circuit to ground of metering unit output	√	-					
		Open load of metering unit output	-	○					
P0252	Powerstage error	-	○						
PRV (rail) pressure regulator valve	P0092	Short circuit to battery of pressure control valve output	√	-		√	<ul style="list-style-type: none"> • PRV circuit • PRV 		
	P0091	Short circuit to ground of pressure control valve output							
		Open load of pressure control valve output							
P0089	Powerstage error								
OPS oil pressure sensor	-	Oil pressure low (below 0.8 bar)	-	-		√	• Oil switch, Oil level, Circuit check		
Charging Error	-	Charging system error	-	-		√	• Alternator, Charging circuit check		
E(C)TS engine coolant temp. sensor	-	Coolant temperature high (above 110°C)	-	Depending temp.	EOI LCD Blinking	√	<ul style="list-style-type: none"> • ECTS circuit • ECTS • Cooling line check 		



7.2 DTC(DIAGNOSIS TROUBLE CODE) LIST

NO	P code	DESCRIPTION
1	P0016	Crankshaft Position – Camshaft Position Correlation
2	P0047	Turbocharger Boost Control Solenoid Circuit Low
3	P0048	Turbocharger Boost Control Solenoid Circuit High
4	P0069	Manifold Absolute Pressure – Barometric Pressure Correlation
5	P0087	Fuel Rail/System Pressure - Too Low
6	P0088	Fuel Rail/System Pressure - Too High
7	P0089	Fuel Pressure Regulator 1 Performance
8	P0091	Fuel Pressure Regulator 1 Control Circuit Low
9	P0092	Fuel Pressure Regulator 1 Control Circuit High
10	P0097	Intake Air Temperature Sensor 2 Circuit Low
11	P0098	Intake Air Temperature Sensor 2 Circuit High
12	P0107	Atmospheric Pressure Sensor Voltage Lower Limit
13	P0108	Atmospheric Pressure Sensor Voltage Upper Limit
14	P0112	Intake Air Temperature Sensor1 Circuit Low Input
15	P0113	Intake Air Temperature Sensor1 Circuit High Input
16	P0116	Engine Coolant Temperature Circuit Range / Performance
17	P0117	Engine Coolant Temperature Circuit Low Input
18	P0118	Engine Coolant Temperature Circuit High Input
19	P0182	Fuel Temp Sensor A Circuit Low Input
20	P0183	Fuel Temp Sensor A Circuit High Input
21	P0192	Fuel Rail Pressure Sensor Circuit Low input
22	P0193	Fuel Rail Pressure Sensor Circuit High Input
23	P0194	Fuel Rail Pressure Sensor Circuit Intermittent
24	P0200	Injector Circuit Error
25	P0201	Cylinder 1 Injector Open Load
26	P0202	Cylinder 2 Injector Open Load
27	P0203	Cylinder 3 Injector Open Load
28	P0204	Cylinder 4 Injector Open Load
29	*P0205	Cylinder 5 Injector Open Load
30	*P0206	Cylinder 6 Injector Open Load
31	P0231	Fuel Pump Secondary Circuit Low



INSTALLATION & OPERATION MANUAL

S270 Series Engines

HYUNDAI SEASALL

NO	P code	DESCRIPTION
32	P0232	Fuel Pump Secondary Circuit High
33	P0234	Turbocharger Over boost Condition
34	P0237	Turbocharger Boost Sensor "A" Circuit Low
35	P0238	Turbocharger Boost Sensor "A" Circuit High
36	P0252	Pump Pressure Regulation Valve Circuit
37	P0253	Pump Pressure Regulation Valve Circuit Low
38	P0254	Pump Pressure Regulation Valve Circuit High
39	P0261	Cylinder 1 - Injector Circuit Low
40	P0262	Cylinder 1 - Injector Circuit High
41	P0263	Cylinder 1 Contribution/Balance
42	P0264	Cylinder 2 - Injector Circuit Low
43	P0265	Cylinder 2 - Injector Circuit High
44	P0266	Cylinder 2 Contribution/Balance
45	P0267	Cylinder 3 - Injector Circuit Low
46	P0268	Cylinder 3 - Injector Circuit High
47	P0269	Cylinder 3 Contribution/Balance
48	P0270	Cylinder 4 - Injector Circuit Low
49	P0271	Cylinder 4 - Injector Circuit High
50	P0272	Cylinder 4 Contribution/Balance
51	*P0273	Cylinder 5 - Injector Circuit Low
52	*P0274	Cylinder 5 - Injector Circuit High
53	*P0275	Cylinder 5 Contribution/Balance
54	*P0276	Cylinder 6 - Injector Circuit Low
55	*P0277	Cylinder 6 - Injector Circuit High
56	*P0278	Cylinder 6 Contribution/Balance
57	P0299	Turbocharger Under boost
58	P0300	Random/Multiple Cylinder Misfire Detected
59	P0335	Crankshaft Position Sensor A Circuit
60	P0336	Crankshaft Position Sensor A Circuit Range/Performance
61	P0340	Camshaft Position Sensor A Circuit Malfunction



INSTALLATION & OPERATION MANUAL

S270 Series Engines

HYUNDAI SEASALL

NO	P code	DESCRIPTION
62	P0341	Camshaft Position Sensor A Circuit Range/Performance
63	P0381	Glow Plug/Heater Indicator Circuit
64	P0562	System Voltage Low
65	P0563	System Voltage High
66	P0601	Internal Control Module Memory Check Sum Error
67	P0602	Control Module Programming Error
68	P0604	Internal Control Module Random Access Memory (RAM) Error
69	P0605	Internal Control Module Read Only Memory(ROM) Error
70	P0606	ECM/PCM Processor
71	P0611	Injector Circuit Error
72	P062D	Injector Bank1 Error
73	P062E	Injector Bank2 Error
74	P0642	Sensor Reference Voltage "A" Circuit Low
75	P0643	Sensor Reference Voltage "A" Circuit High
76	P0650	Malfunction Indicator Lamp(MIL) Control Circuit
77	P0652	Sensor Reference Voltage "B" Circuit Low
78	P0653	Sensor Reference Voltage "B" Circuit High
79	*P0670	Glow Plug Module Control Circuit
80	*P0671	Cylinder 1 Glow Plug Circuit
81	*P0672	Cylinder 2 Glow Plug Circuit
82	*P0673	Cylinder 3 Glow Plug Circuit
83	*P0674	Cylinder 4 Glow Plug Circuit
84	*P0675	Cylinder 5 Glow Plug Circuit
85	*P0676	Cylinder 6 Glow Plug Circuit
86	*P0683	Glow Control Module Signal
87	*P0684	Glow Control Module Performance
88	P0685	ECM/PCM Power Relay Control Circuit /Open
89	*P0698	Variable Swirl Actuator Voltage Lower Limit
90	*P0699	Variable Swirl Actuator Voltage Upper Limit
91	P1145	Overrun Monitoring



INSTALLATION & OPERATION MANUAL

S270 Series Engines

HYUNDAI SEASALL

NO	P code	DESCRIPTION
92	P1171	Minimum Rail Pressure Exceeded
93	P1172	Maximum Rail Pressure Exceeded
94	P1173	Set Value of PCV not in Plausibility Range
95	P1185	Maximum Pressure Exceeded
96	P1186	Minimum Pressure at Engine Speed Too Low
97	P1187	Regulator Valve Stick
98	P1188	Leakage
99	P1307	Acceleration Sensor Range/Performance
100	P1308	Acceleration Sensor Circuit Low Input
101	P1309	Acceleration Sensor Circuit High Input
102	P1325	Glow Relay Malfunction
103	P1636	Voltage Regulator for Injector
104	P1652	Ignition Key No Signal
105	P1653	After-Run Check Error
106	P1655	Tachometer Output Fault
107	P1670	Invalid Injector IQA/C2I
108	P1671	Injector IQA Checksum Error
109	P1679	EMS Data Fail (Data frame, CS, Message error)
110	P1694	EMS Message Error
111	P1695	EMS Memory Error
112	P1697	HI-SCAN message Error
113	*P2009	Variable Swirl Actuator Control Circuit Low(Bank 1)
114	*P2010	Variable Swirl Actuator Control Circuit High(Bank 1)
115	*P2015	Variable Swirl Actuator Position Sensor/Switch Circuit Range/Performance
116	*P2016	Variable Swirl Actuator Position Sensor/Switch Circuit Low
117	*P2017	Variable Swirl Actuator Position Sensor/Switch Circuit High
118	P2122	Throttle/Pedal Position Sensor/Switch "D" Circuit Low Input
119	P2123	Throttle/Pedal Position Sensor/Switch "D" Circuit High Input
120	P2127	Throttle/Pedal Position Sensor/Switch "E" Circuit Low Input
121	P2128	Throttle/Pedal Position Sensor/Switch "E" Circuit High Input



INSTALLATION & OPERATION MANUAL

S270 Series Engines

HYUNDAI SEASALL

NO	P code	DESCRIPTION
122	P2138	Throttle/Pedal Position Sensor/Switch "D" / "E" Voltage Correlation
123	P2228	Barometric Pressure Circuit Low Input
124	P2229	Barometric Pressure Circuit High Input
125	P2262	Turbocharger Boost Pressure Not Detected - Mechanical
126	P2263	Turbocharger Boost System Performance
127	P2265	
128	P2266	
129	P2267	
130	P2268	
131	P2264	Water in Fuel Sensor Circuit
132	*P2562	Turbocharger Boost Control Position Sensor "A" Circuit
133	*P2563	Turbocharger Boost Control Position Sensor "A" Circuit Range/Performance
134	*P2564	Turbocharger Boost Control Position Sensor "A" Circuit Low
135	*P2565	Turbocharger Boost Control Position Sensor "A" Circuit High
136	*P2566	Turbocharger Boost Control Position Sensor "A" Circuit Intermittent
137	U0001	Abnormal communication signals (CAN)
138	U0100	No communication signals (CAN)

*Pxxxx codes apply to S250 and S270 models



CHAPTER 10
ANTI CORROSION SYSTEM

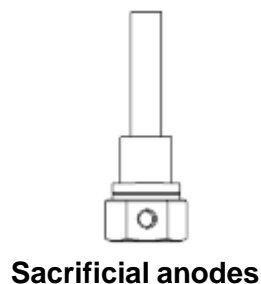
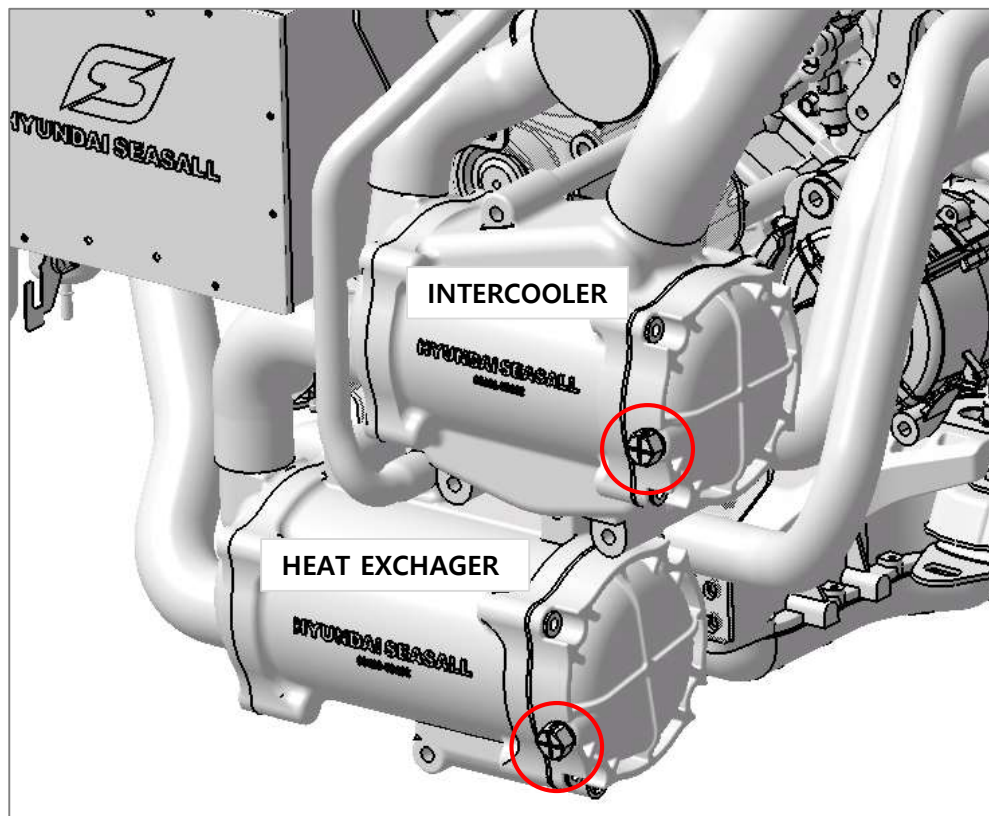

- 1) Sacrificial anode must be replaced every 250 hours or if more than 60% has been used.
- 2) Check especially frequently when used in saltwater. It is recommended to replace the sacrificial anodes at the start of each season.



CAUTION

- DON'T OPERATE ENGINE WITHOUT ANODES. IT IS HARMFUL TO YOUR ENGINE.
- CLOSE THE SEAWATER VALVE BEFORE THIS MAINTENANCE.
- MAKE SURE TO CHECK THE ANODE PLUG IN ACCORDANCE WITH THIS MANUAL; DON'T LOOSEN COOLANT DRAIN PLUG.

CHAPTER 11
ENGINE OPERATION

1. ENGINE ON/OFF

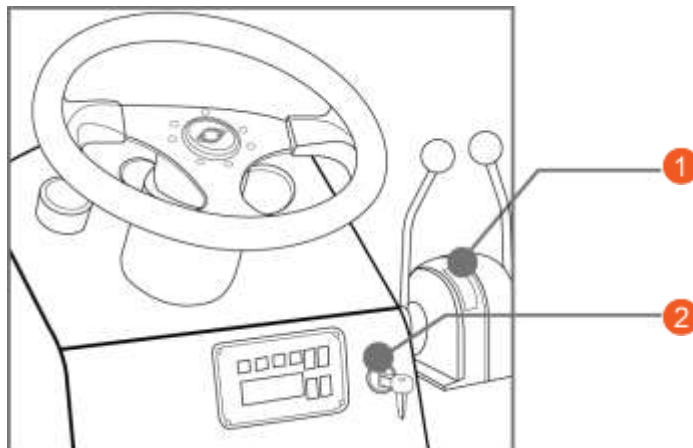

- 1) Before starting the engine, you should check engine oil, coolant, gearbox oil, fuel gauge, seawater pump, battery, seacocks and so on.
- 2) When you start the engine, check that the engine throttle lever① is in the neutral position. If not, the engine may not start or there is possibility of the boat moving inadvertently. If your boat is equipped with a neutral safety switch, the engine will only crank when the engine throttle lever is in the neutral position. You can also check this on the EOI.
- 3) After starting the engine, release the key② immediately to prevent damage to the starter motor.
- 5) Avoid maximum rpm and WOT (Wide Open Throttle) before the cold engine is fully warmed up.
- 6) When cold starting, it may take a few more seconds to start the engine.
- 7) If the engine does not start in 10 seconds, release the key and wait 10 seconds. After 10 seconds try again. This method can help avoid starter motor damage.



WARNING

**DO NOT DRIVE IN SPACE WHERE THERE IS NO AIR CIRCULATION.
EMISSION GAS IS HARMFUL.**

2. ENGINE BREAK-IN

Initial Break-in Procedure

The first 20 hours of operation is the engine break-in period. During this period, it is important that the engine is operated as outlined below.

- 1) DO NOT operate engine at idle rpm for extended periods of time during the first 10 hours.
- 2) DO NOT operate at any one constant speed for extended periods of time.
- 3) DO NOT exceed 75% of full throttle during the first 10 hours. After the next 10 hours, occasional operation at full throttle (5 minutes at a time maximum) is permissible.
- 4) AVOID full throttle accelerations from neutral position.
- 5) DO NOT operate at all full throttle until engine reaches normal operating temperature.
- 6) FREQUENTLY CHECK engine oil level and add oil if necessary.

STOPPING THE ENGINE

The engine should be run for a few minute at idle (in neutral) before turning it off. This will avoid boiling the cooling system and even out the temperature.

This is especially important if the engine has been operated at high engine speeds and/or with heavy loads.

Shutting down the engine in this fashion will extend the life of your engine.



WARNING

**DO NOT OPERATE IN SPACES WHERE THERE IS NO AIR CIRCULATION.
EXHAUST GAS IS HARMFUL.**

3. EMERGENCY STOP

- 1) You can stop the engine by pushing this button. After releasing the switch, you can start the engine again. (Normally, the button should be in the “out” position.)
- 2) When the button is pressed or it doesn't work normally, the engine won't crank. We recommend that you check this switch first if there is any cranking problem.
- 3) You can use this switch to avoid unexpected engine starting during maintenance.
- 4) You can use this switch for any emergency situation when you want to stop the engine.

Engine stop Switch

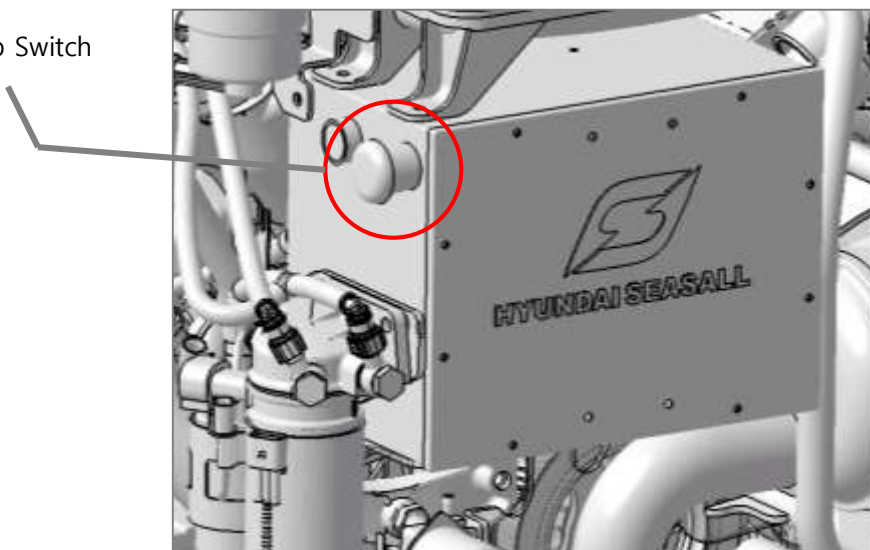

CHAPTER 12
ENGINE STORAGE

The major consideration in preparing your engine for storage is to protect it from rust, corrosion, and damage caused by freezing of trapped water.

The following storage procedures should be followed to prepare your engine for out-of-season storage or prolonged storage (two months or longer and/or winter storage) :

CHECK LIST
• Visual inspection for leaks and damage
• Change engine oil and oil filter
• Replace fuel filter
• Check air filter element and clean if necessary
• Check engine coolant level and top up if necessary
• Check impeller for wear. If in good condition, remove and store in a dark, dry place. If replacement is required, prepare a new impeller to be installed when the engine is put back into service.
• Check anode and replace if necessary
• Clean the engine
• Flush and drain seawater cooling system
• Fill fuel tank until full and inspect the fuel system
• Remove the battery and store in a cool, dry place



CAUTION

FOR OVER-WINTERING, SEAWATER SHOULD BE DRAINED FULLY BY LOOSENING HEAT EXCHAGER ANODE. REFER TO CHAPTER 10.

WINTER STORAGE

Protect your engine from freezing and corrosion damage by following the procedures indicated below.

• LUBRICATION SYSTEM

- Start the engine and allow it to reach normal operating temperature.
- Turn off the engine. Drain the engine oil using the oil extraction pump. If the oil extraction pump is not installed, drain oil by removing the oil pan drain plug.
- Change the oil and oil filter and refill the engine with new oil according to technical maintenance specifications.
- Check the oil level on the dipstick and if necessary add more oil to reach the correct oil level.

• FUEL SYSTEM

- Check for fuel leaks where the line from the fuel tank connects to the engine. Tighten or replace the connection if necessary.
- Close the fuel valve. Clean the water separating fuel filter. Replace the filter element.
- After replacing the filter element, open the fuel valve to fill the entire fuel circulation line.
- Fill the fuel tank with fresh fuel to avoid condensation in the fuel tank.
- Close the fuel valve.

• COOLING SYSTEM

- Close the water valve.
- Connect a freshwater source to the seawater inlet. Run the engine at idle to flush all seawater out of the system.
- Fill the cooling system (seawater side) with a 30~50% solution of anti-freeze. Circulate into the seawater system by running the engine.

• COOLING SYSTEM

- If the seawater system is not filled with an antifreeze solution as per the instructions above, completely drain the seawater system by removing the heat exchanger and intercooler anodes.
- Check impeller for wear. If in good condition, remove and store in a dark, dry place. If replacement is required, prepare a new impeller to be installed when the engine is put back into service.
- Check all connections with inlet hoses. Tighten or replace the connection if necessary.
- Check the cooling system (heat exchanger, intercooler, thermostat, hoses, clamps, etc.) every 500 hours or every two years, whichever comes first. Replace any worn components.

• INTAKE SYSTEM

- Remove the air filter from engine.
- Clean the air filter.
- Intake port should be kept hermetically sealed.

• ELECTRICAL SYSTEM

- Disconnect the battery (-) cable to system ground
- Disconnect the battery (+) cable.
- Clean the battery cable and terminals.
- Coat the terminal connection with a battery terminal anti-corrosion agent.
- Whenever the battery will be stored for an extended period of time, be sure the cells are full of electrolyte and that the battery is fully charged.

LONG TERM STORAGE

These instructions must be followed in order to obtain warranty coverage for long term storage engines. These procedures are intended to prevent oxidation and deterioration of engine and fuel system components.

Engines stored for more than one (1) year must be inspected properly to ensure that they are in good condition.

- Engines used within one (1) year from factory release.
 - No specific action is required.

- Engines stocked more than one (1) year from factory release(To check every 6 months)
 - 1) Carefully inspect & check all parts for damage and/or corrosion.
 - 2) The coolant must be replaced for long term storage. *Use 50% Glycol containing anti-corrosion additives and 50% distilled water.*
 - 3) Check *all anodes* and replace if required.
 - 4) Storage conditions should be between 15~30°C and less than 50% relative humidity.

- Engines for use after long term storage and/or long term inactivity.
 - 1) Carefully inspect and check all parts for damage and/or corrosion.
 - 2) The coolant and lubricants must be replaced before using the engine.
 - 3) The oil filter and fuel filter must be replaced before using the engine.
 - 4) The seawater pump impeller must be replaced before using the engine.
 - 5) The thermostat and anodes must be checked and replaced if necessary
 - 6) Crank the engine without starting to lubricate the inside of the engine. Please disconnect the Crank Position Sensor to prevent engine start while lubricating the engine.
 - 7) Run the engine 10 minutes at idle RPM with no load before putting into service.
 - 8) Refer to Pre-Delivery checklist to inspect entire engine condition and installation.

CHAPTER 13
MAINTENANCE

1. THE INITIAL RUNNING CHECK

- BEFORE THE WATER TEST

	Y	N
Seawater inlet valve open		
Engine coolant level		
Cooling system hose clamps tight		
Engine oil level		
Power steering fluid level		
Drive belt tension		
All electrical connections tight		
EOI warning system operating		
Battery fully charged and secured		
All fuel connection tight		
Exhaust system hose clamps tight		
Engine mount tight		
Engine alignment		
Correct rotation propeller (Installed and torque)		
Engine coolant and oil drain plug closed		
Throttle, shift and steering system fasteners tightened properly		

- AFTER THE WATER TEST

Fuel, oil, coolant, water and fluid leaks		
Oil and fluid level		
Propeller nut torque		

- ON THE WATER TEST

	Y	N
Boat drain plug in place (Check before putting boat in water)		
Seawater pump operation		
Seawater strainer correctly mounted , Clean and tightly closed		
Engine alignment (propulsion only)		
Fuel leaks		
Oil leaks		
Coolant leaks		
Water leaks		
Exhaust leaks		
EOI and gauges operation		
Engine emergency stop switch operation		
Idle RPM, within specifications		
WOT RPM, within specifications (in forward gear)		

- PROPULSION CHECKS

Stern drive unit oil level		
Power trim oil level (stern drives)		
Drive unit fasteners torque		
Power trim cylinders fasteners tight		
Propeller nut torque		
Transmission fluid level		
Steering operation throughout range		
Power trim operation (stern drives)		
Forward - Neutral - Reverse gear operation		



INSTALLATION & OPERATION MANUAL

S270 Series Engines

2. MAINTENANCE SCHEDULE

○ : Check/Clean, ◇ : Check (Replace if necessary), ● : Replace

Item	Interval	Which ever comes first				
		Daily	Every 250 Hours / 1 years	Every 500 Hours / 2 years	Every 1,000 Hours / 4 years	Every 1,500 Hours / 5 years
Coolant level and leakage ¹⁾		○				
Sea water strainer		○				
Exhaust system leakage		○				
Fuel system leakage		○				
Engine oil level and leakage		○				
Battery voltage		○				
Steering system oil level and leakage		○				
Transmission ²⁾ oil level and leakage		○				
Fuel filter and water separator			●			
Engine oil and oil filter			●			
Sacrificial anode			●			
Connections and corrosion in electric system.			◇			
Loose bolts and nuts.			◇			
Loose or damaged hose clamps			◇			
Exhaust bellows			◇	●		
Sea water pump impeller			◇	●		
Air filter			◇		●	
Engine Mounts			◇		●	
Drive belt				◇		●
Heat Exchanger (Tube bundle)				◇		◇
Intercooler (Tube bundle)				◇		◇
Turbocharger					◇	
E-VGT Cooler			◇			

1) Replace the coolant every 2 years.

2) For more detailed transmission, follow the transmission manufacturer's manual.

* NOTE : These procedures are considered normal maintenance.



CAUTION

YOU SHOULD EXERCISE THE UTMOST CARE TO PREVENT INJURY TO YOURSELF OR ENGINE DAMAGE WHENEVER PERFORMING ANY MAINTENANCE.



3. STERNDRIVE & TRANSMISSION MAINTENANCE SCHEDULE

Maintenance item	Maintenance intervals	Whichever comes first	
		Daily	100h / 1year
Check sterndrive unit oil level (Transmission)		●	
Trim pump oil level		●	
Steering fluid level		●	
Check water pickups for debris or marine growth		●	
Check water strainer and clean		●	
Inspect sterndrive unit anodes and replace if 50% eroded		●	
Lubricate propeller shaft and the retorque nut		●	
Touch-up power package paint and spray with Corrosion Guard (Transmission)			●
Change sterndrive unit oil (Transmission)			●
Retorque connection of gimbalring to steering shaft			●
Check steering system and remote control for loose, missing or damaged parts			●
Lubricate cables and linkages			●
Inspect U-joints, splines and bellows. Lubricate U-joints splines			●
Check engine alignment			●
Check gimbal bearing and engine coupler			●
Check continuity circuit for loose or damaged connections			●
Check MerCathode unit			●

Filter replacement (ZF Transmission)

- 1) The first replacement must be preformed after 25 hours of operation.
- 2) The oil must be changed whenever the filter is replaced.



CAUTION
 YOU SHOULD EXERCISE THE UTMOST CARE TO PREVENT INJURY TO YOURSELF OR ENGINE DAMAGE WHENEVER PERFORMING ANY MAINTENANCE.

CHAPTER 14
TROUBLESHOOTING GUIDE

■ Starter motor does not crank the engine

Possible Causes	
• Engine stop switch “ON” position	• Engine is not shifted to neutral position • Wrong neutral switch connection to EOI
• Weak battery or battery connections are loose or corroded	• Starter motor solenoid or slave solenoid failure
• Ignition key switch failure	• Blown fuse at EOI
• Wiring or electrical connection fault	• Defective ECU

■ Engine cranks but does not start

Possible Causes	
• Weak battery or bad starter motor	• Low fuel pressure
• No fuel	• Low compression pressure
• ECU not functioning	• Crank position sensor not functioning
• Incorrect starting procedure	• Fuel is not reaching the engine
• Faulty fuel filter or electric fuel pump	• Bad fuel quality or water in fuel
• Faulty fuse	• Faulty injector

■ Engine starts with difficulty or starts and stalls

Possible Causes	
• Low fuel pressure in fuel rail	• Fuel return line not connected at injector
• Leakage in high pressure fuel circuit	• Faulty alternator or voltage regulator
• Faulty fuse	• No engine coolant temperature sensor signal
• No rail pressure sensor signal	• Low battery voltage
• Oil level too high or too low	• Low compression pressure
• ECU program error or hardware fault	• Clogged fuel filter

■ Engine idle is rough

Possible Causes	
• Fuel return line not connected at injector	• Low compression pressure
• No rail pressure sensor signal	• Injector clamp poorly tightened
• Wiring harness open or poor connection	• Faulty high pressure fuel pump
• Bad fuel quality or water in fuel	• Faulty injector
• Clogged fuel filter / air filter	• Carbon deposit on the injector

■ **Engine rattling, noisy engine**

Possible Causes	
• Compensation of individual injector not adapted	• No engine coolant temperature sensor signal
• Low compression pressure	• Clogged injector return line
• No rail pressure sensor signal	• Faulty injector
• Poor injector O-ring	• Carbon deposit on the injector

■ **Uncommanded acceleration / deceleration**

Possible Causes	
• Intermittent faulty fuel line connection	• Oil suction
• No rail pressure sensor signal	• ECU program error or hardware fault
• Leakage in intake system	• Damaged turbocharger or leakage in vacuum line
• Clogged fuel filter	• Low compression pressure
• Leakage in high pressure fuel circuit	• Injector needle stuck

■ **Engine stops**

Possible Causes	
• Run out of fuel / Safety Stop Switch activated	• Fuel return line not connected at injector
• Fuel feed line not connected	• Fuel pressure regulator valve contaminated, stuck, jammed
• Leakage in high pressure fuel circuit	• Rail pressure regulator valve contaminated, stuck, jammed
• Fuel out of specification	• Faulty alternator or voltage regulator
• Bad fuel quality or water in fuel	• Faulty high/low pressure fuel pump
• Clogged low pressure fuel circuit	• ECU program error or hardware fault

■ **Performance loss**

Possible Causes	
• Compensation of individual injector not adapted	• Leakage at the injector
• Clogged air filter	• Fuel or intake air temperature too high
• Oil level too high or too low	• Engine coolant temperature too high
• Damaged turbocharger or intake air leakage	• Low compression pressure
• Clogged fuel filter	• Poor valve clearance

CHAPTER 15
WARRANTY

HYUNDAI SEASALL RATING CATEGORIES FOR MARINE ENGINE

S5 : Pleasure Duty

- Full power operation restricted to within 10% of total use period
 - * Continuous maximum output restricted to 0.5 hours within 12 hours period
- Cruising speed (RPM) at engine RPM < 90% of rated speed (RPM)
- Operating less than 400 hours per year

S4 : Special Pleasure Duty / Special Light Duty Commercial

- Full power operation restricted to within 10% of total use period
 - * Continuous maximum output restricted to 1 hours within 12 hours period
- Cruising speed (RPM) at engine RPM < 90% of rated speed (RPM)
- Operating less than 1,000 hours per year

S3 : Light Duty Commercial

- Full power operation restricted to within 20% of total use period
 - * Continuous maximum output restricted to 2 hours within 12 hours period
- Cruising speed (RPM) at engine RPM < 90% of rated speed (RPM)
- Operating less than 1,500 hours per year

S2 : Medium Duty Commercial

- Full power operation restricted to within 30% of total use period
 - * Continuous maximum output restricted to 4 hours within 12 hours period
- Cruising speed (RPM) at engine RPM < 90% of rated speed (RPM)
- Operating less than 3,000 hours per year

S1 : Heavy Duty Commercial

- Uninterrupted and unlimited use at full power.

APPLICATION OF WARRANTY COVERAGE

Warranty coverage is available only to retail customers who purchase from a dealer authorized by Hyundai SeasAll to distribute the product in the country in which the sale occurred, and then only after the Hyundai SeasAll specified pre-delivery inspection process is completed and documented. Warranty coverage becomes available upon proper registration of the product by the authorized dealer. Routine maintenance outlined in the Installation and Operation Manual must be performed in a timely fashion in order to obtain warranty coverage. Hyundai SeasAll reserves the right to make any warranty coverage contingent upon proof of proper maintenance.

This warranty may be rendered invalid at Hyundai SeasAll's discretion based upon:

- 1) Modifications not authorized by Hyundai SeasAll
- 2) Handling errors
- 3) Improperly performed Pre-Delivery Inspection
- 4) Unsuitable fuels, coolant or lubricants
- 5) Using the engine outside of the specified duty cycle rating
- 6) Overloading
- 7) Improperly performed repairs
- 8) Improper maintenance interval(s)
- 9) No submitted Pre-Delivery Inspection Card and Warranty Registration Card



INSTALLATION & OPERATION MANUAL

S270 Series Engines

DURATION OF WARRANTY

Leisure Applications

Engine	Rating	Base Engine		Extended Major Components (Includes Base Engine Warranty)	
		year	hour	year	hour
U125/D170/ R200/S270	S5	2	1,000	4	2,000
**H380/L500/ G300	S5	2	-	4	5,000

** Operating less than 1,500 hours per year and Full Power operation < 10% of total use period

- Warranty period is limited by Years or Hours whichever occurs first.
- Major Components : Engine Block Casting, Crankshaft Forging, Connecting Rods, Camshaft Forging, Transmission Cover/Housing, Flywheel Housing, Intake Manifold, Fresh Water Pump Housing and Oil Pan.
- Cylinder Liner or Cylinder Bore scratches are not included in extended major part warranty coverage.

Commercial Applications

Engine	Rating	Base Engine		Extended Major Components (Includes Base Engine Warranty)	
		years	hours	years	hours
U125/D170/ R200/S270	S4	1	1,000	3	2,000
D150/S220 G350/L700	S3	1	1,500	3	6,500
H410/H450 L600	S2	1	3,000	3	6,000
G300 H200/H238/H250/ H310/H345/H380/ L200/L310/L380/ L400/L420/L450/ L460/L500/L530	S1	1	5,000	3	10,000
M70/M100/M130 Q280/Q330/Q360					

- Warranty period is limited by Years or Hours whichever occurs first.
- Major Components : Engine Block Casting, Crankshaft Forging, Connecting Rods, Camshaft Forging, Transmission Cover/Housing, Flywheel Housing, Intake Manifold, Fresh Water Pump Housing and Oil Pan.
- Cylinder Liner or Cylinder Bore scratches are not included in extended major part warranty coverage.



INSTALLATION & OPERATION MANUAL

S270 Series Engines

HYUNDAI SEASALL

Hyundai SeasAll Rating Categories For Marine Auxiliary Engine

(Ratings in accordance with ISO 8528)

Standby Power

- 1) Operating less than 500 hours per year with average 90% load of the declared Standby Power
- 2) No overload capability is available for this rating.

Prime Power

- 1) Average power operation is not exceed 70% of the declared Prime Power.
- 2) A 10% overload is permissible for 1 hour per 12 hours of operation.
- 3) Maximum prime power shall not exceed 500 hours per year.

Marin Auxiliary Engine

Engine	Rating	Base Engine		Extended Major Components (Included Base Engine Warranty)	
		year	hour	year	Hour
M40G/M55G/M70G H10G L13G	Standby Power	2	1,000	4	3,000
	Prime Power	1	-	3	10,000

Genset

Model		Warranty Classification	
		Prime Power	Standby Power
60 HZ 1,800 RPM 220V * 3P	HSMG107 HSMG380 HSMG500	1year	2 years/ 1000 hours

WARRANTY STARTING DATE

Warranty Begins:

- 1) When engine is delivered to the first retail purchaser
- 2) When the engine is first leased or rented
- 3) When the products reaches the first day of the 7 month after the product has been shipped from Hyundai SeasAll, the warranty date will be started automatically. If you submit the "Pre-Delivery Inspection Card" and "Warranty Registration Card", the starting date can be changed to the date on your documents.

WARRANTY REGISTRATION

Warranty Registration Card must be submitted to Hyundai SeasAll within 30 days of the Warranty Starting Date. The Warranty Registration Card identifies information on customer and product, models and serial numbers, date of sale, type of use and the selling dealer etc. If the 'Warranty Registration Card' and 'Pre-Delivery Inspection Card' are not approved or not submitted to Hyundai SeasAll within 30 days from Warranty Starting Date, Hyundai SeasAll reserves the right to decline warranty reimbursement.

TRANSFER OF WARRANTY COVERAGE BETWEEN OWNERS

This limited warranty is transferable to a subsequent purchaser, but only for the remainder of the unused portion of the limited warranty. To transfer the warranty to the subsequent owner, the revised “Warranty Registration Card” and “Pre-Delivery Inspection Card” should be submitted to Hyundai SeasAll’s distributor or dealer. Upon processing the transfer of warranty, Hyundai SeasAll will verify the warranty registration of the new owner.

WHAT HYUNDAI SEASALL WILL DO

Hyundai SeasAll will pay for all parts and labor needed to repair the damage to the product resulting from a defect in materials or factory workmanship.

The warranty does not apply to any damage or defect that is the result of abnormal use or carelessness.

The repair or replacement of parts, or the performance of service under this warranty does not extend the life of this warranty beyond its original expiration date.

OWNER’S OBLIGATIONS

It is the owner’s obligation to install, operate, maintain and care for Hyundai SeasAll engines in accordance with the instructions and requirements stated in the Installation and Operation Manual.

The owner is responsible for providing enough time and cooperation to get the engine repaired by an authorized dealer, and to deliver it to a proper facility for repair.

The owner is responsible for the cost for warranty inspection, including hauling out, launching and transportation.

BUSINESS PARTNER’S OBLIGATIONS

It is Hyundai SeasAll’s Distributor and/or Dealer’s responsibility to support the retail customer with prompt diagnosis and repair whether or not the engine was sold by the servicing dealer or by the Distributor responsible for the territory.

It is Hyundai SeasAll’s Distributor’s responsibility to communicate all warranty issues to the factory in a timely manner so that they can be quickly resolved.

HOW TO OBTAIN WARRANTY COVERAGE

The customer must provide Hyundai SeasAll with a reasonable opportunity to repair the engine, as well as reasonable access to the product for warranty service. Warranty claims shall be made to a Hyundai SeasAll Authorized Repair Facility to service the product. Purchaser shall not, unless requested by Hyundai SeasAll, ship the product or parts of the product directly to Hyundai SeasAll. The warranty registration card is the only valid registration identification and must be presented to the dealer at the time warranty service is requested in order to obtain coverage.

WHAT IS COVERED

Hyundai SeasAll warrants its products to be free of defects in material and workmanship during the warranty period.

LIMITATIONS – EXPENDABLE PARTS

Not included are the following expendable parts:

- Filters : fuel filter, engine oil filter, air filter
- Lubricants : engine oil, coolant, power steering oil.
- Rubber products : seawater pump impeller, rubber hoses, belts, engine coupler, rubber isolation mounts, bellows.
- Gaskets, anodes.

WHAT IS NOT COVERED

- Fuel injector or filter cleaning
- Belt, cable adjustments or lubrication checks made in connection with normal services.
- Damage caused by neglect, lack of maintenance, accidents, abnormal operation, improper installation or service, unapproved modifications or freezing temperatures.
- Haul-out (crane), launching or towing charges, removal and/or replacement of boat partitions or material for necessary access to the product, all related transportation charges and/or travel time, etc.
- All incidental and/or consequential damages (storage charges, telephone or rental charges of any type, inconvenience or loss of time or income) are the owner's responsibility.
- Use of other than Hyundai SeasAll genuine replacement parts when making warranty repairs.
- Participating in or preparing for racing or other competitive activity.
- Water entering the engine via the air inlet filter or exhaust system or submersion. Water in the starter motor.
- Failure of any parts caused by lack of cooling water.
- Damage caused by blockage of the cooling system by foreign matter.
- Use of fuels and lubricants that are not suitable for use with or on the product as specified in the Installation and Operation Manual.
- Normal wear and tear
- Storage damage (such as paint scratches)
- Cost resulting from ineffective or repeated repairs; improper repairs due to misdiagnosis.
- Owner's personal cost (indirect loss) resulting from maintenance.

TRANSMISSION AND STERNDRIVE WARRANTIES

Transmissions and drive systems (ZF, Mercury Marine etc.) are covered under separate warranties, provided and serviced by those companies. For information on those warranties, please see the separate booklets included in the original packaging of your Hyundai SeasAll purchase.

This card is essential for registration of the customer's warranty.
 Please fill out the following registration card in English.

Date of sale

Month	Day	Year

If Warranty Transfer , Check box

OWNER'S INFORMATION

Name or Company		E-Mail Address	
Country		State / Province / City	
Operating Location			

DEALER INFORMATION

Dealer / Installer		Distributor Name	
City		E-Mail Address	

ENGINE INFORMATION

Number of Engines	Single <input type="checkbox"/>	Dual <input type="checkbox"/>
-------------------	---------------------------------	-------------------------------

Engine Model		Gear Model	
Engine Serial No.		Gear/Drive Serial No.	
		Transom Serial No.	

Engine Model		Gear Model	
Engine Serial No.		Gear/Drive Serial No.	
		Transom Serial No.	

BOAT INFORMATION

REPOWER

Manufacturer		Material	Steel <input type="checkbox"/>	Alu. <input type="checkbox"/>	FRP <input type="checkbox"/>	Wood. <input type="checkbox"/>
Model		LOA	ft	Beam	ft	
Boat Type		Hull ID				
Type of Use	Pleasure <input type="checkbox"/>	Commercial <input type="checkbox"/>	Planning <input type="checkbox"/>	Semi Disp. <input type="checkbox"/>	Displacement <input type="checkbox"/>	

Dealer's Instructions: Dealers must complete this card to register the warranty. Please return the copy to your national Importer/Distributor immediately. Unregistered engines are subject to warranty rejection.

REMARKS

SIGNATURE : _____